

A TRADITION OF QUALITY SINCE 1903

Hallowell®

COMPLETE STORAGE SOLUTIONS FULL-LINE CATALOG

2023
UPDATE

CABINETS • GUARD RAIL • SHELVING • METAL LOCKERS • GATES • WORKBENCHES



**ALL IN-STOCK
PRODUCTS**

WWW.HALLOWELL-LIST.COM

MADE IN AMERICA

6

**DISTRIBUTION
CENTERS
NATIONWIDE**

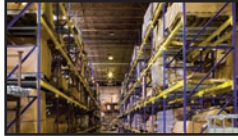

THE INDUSTRY'S LARGEST INVENTORY

- Six fully-stocked regional distribution centers.
- Over 4,000 different skus to choose from in stock.
- Large inventory covers of best solvers.



ALL LOCKERS & CABINETS ARE AVAILABLE TO SHIP KNOCK DOWN OR FULLY-ASSEMBLED

- Lockers and cabinets are assembled by trained and highly skilled trade professionals.
- Lockers and cabinets arrive ready to anchor, saving you time and money.

OUR STEEL

- Most of our steel is purchased directly from US mills and is made of 30% post consumer recycled content and 11.3% post industrial/pre-consumer content.



OUR PAINT

- Sherwin Williams powders are made in the USA insuring no harmful materials.
- Hammertone textured finishes are available for all 24 standard colors.
- Medsafe® antimicrobial finishes with Microban® are available for all 24 colors



WE ARE GREENGUARD GOLD CERTIFIED

- Hallowell is committed to minimizing environmental impact of our products and protecting indoor air quality
- GREENGUARD Gold Certification establishes strict chemical emission standards for products intended for use in environments where children and others work, play or reside.
- All metal products are GREENGUARD GOLD certified



INDUSTRY-LEADING CUSTOMER SERVICE

- A dedicated team of in-house trained professionals is ready to respond to inquiries related to product features, availability, specifications, order status and shipping information.
- All personnel are trained in every aspect of our Quick Ship program.

Since 1903, every Hallowell component has been designed and manufactured with the concept that the highest quality product is crucial for success.

OUR HISTORY

Hallowell was acquired by List Industries Inc. in 1992. List Industries was founded in 1936 with the idea that customer satisfaction and product quality would be the basis for success. This philosophy has been maintained for over 80 years by the three Presidents of List Industries Inc.: founder Max H. List, his son Herb List and his grandson and current President, Herb List, Jr. As an innovator and industry leader in product design and development, List Industries Inc. has and will continue to uphold Hallowell's tradition of quality and exceptional customer service.

MANUFACTURING

Hallowell Products are fabricated in three state-of-the-art manufacturing facilities located in Central and South Florida. Our Deerfield Beach corporate headquarters is a highly efficient manufacturing plant located in one of South Florida's premier office parks. Computer controlled fabrication and roll-forming equipment and the newest powder coating paint technology assure consistent quality workmanship. In addition to our primary manufacturing facility, we also have a second plant in a prestigious industrial park in Central Florida that more than doubles our manufacturing square footage. Our third Florida location, and newest addition, produces our new line of all-wood Recruiter sport lockers and wardrobe Club Lockers.

MADE-TO-ORDER PRODUCTS

In addition to Hallowell's industry leading variety of in-stock lockers, shelving and cabinets we also offer an extensive line of production items. Hallowell's complete line of production lockers (shown on pages 122 through 133) can be manufactured in short lead-times and painted in one of our 24 standard designer powder coat colors (see page 135). If a high-rise shelving system is what you require, our team of design engineers and sales professionals is eager to assist you.



VISIT OUR WEBSITE: www.Hallowell-List.com FOR MORE INFORMATION

TABLE OF CONTENTS

- 2 **Why Hallowell - Company Spotlight**
- 4 **Quick-Ship Program & Distribution Centers**

SHELVING

- 6 **Rivetwell Boltless Shelving**
- 7 Components
- 8 Unit Growth Chart
- 9 Single Rivet Units
- 10 Double Rivet Units
- 11 Record Storage Units
- 12 Automotive Storage Racks
- 13 Components
- 15 Decking
- 17 Technical Data
- 18 **Rivetwell High Capacity Boltless Shelving**
- 19 **High Capacity Bolted Die Rack**
- 20 **Hi-Tech Clip Shelving**
- 22 Open Units
- 23 Closed Units
- 24 Free Standing Open and Closed Units
- 25 Medsafe Antimicrobial Finish Shelving
- 26 Bin Units
- 27 Deep Bin Units
- 28 **H-Post Shelving**
- 32 DuraTech Pass-Thru Shelving
- 34 Components
- 38 Component Specifications
- 40 Multi-Level High Rise Shelving Systems
- 42 Growth & Technical Data
- 44 **Bulk Rack**
- 47 **Reel Rack**
- 48 **Bin Shelving**
- 49 **Portable Gates**
- 50 **Guardrail & Post Protectors**



CABINETS

- 51 **Slimline Cabinets**
- 52 **400-Series Commercial Grade Cabinets**
- 54 **800-Series Industrial Grade Cabinets**
- 56 **DuraTough All-Welded Cabinets**

WORKBENCHES

- 60 **Workbenches**
- 61 **Fort Knox Modular Storage System**



CALL **866-566-0500**
FOR MORE INFORMATION ON OUR QUICK-SHIP PROGRAM

LOCKERS: QUICK-SHIP

- 66 Premium Wardrobe Lockers
- 68 Premium Box Lockers
- 70 Ready-Built Lockers
- 72 Ready-Built II Lockers
- 74 Medsafe Antimicrobial Lockers
- 75 ValueMax Lockers
- 76 Maintenance-Free Quiet KD Lockers
- 78 DigiTech Electronic Day Use Lockers
- 80 Safety-View See-Thru Door Panels
- 81 Safety-View Plus See-Thru Doors
- 82 Digitech Safety-View Plus
- 84 Heavy-Duty Ventilated Lockers
- 86 Locker Accessories
- 88 Wood/Metal Hybrid Lockers
- 90 Wood Club Lockers
- 92 Recruiter Wood Sport Lockers
- 94 Galvanite Rust Resistant Lockers
- 96 Aquamax Solid Plastic Lockers
- 97 Medsafe Aquamax Antimicrobial Solid Plastic Lockers
- 98 Versamax Solid Phenolic Lockers
- 99 Stainless Steel Lockers
- 100 Kid Lockers
- 101 Home Team Lockers
- 102 Cubix Modular Box Lockers
- 103 Cell Phone/Tablet Lockers
- 104 Backpack/Laptop Lockers
- 106 Turn-out Gear Emergency Response Lockers
- 108 Uniform Exchange Lockers
- 110 MaxView Heavy Equipment Storage
- 111 All-Welded Single-Point All-Welded Ventilated
- 112 Task-Force XP Emergency Response Lockers
- 114 Rookie KD Gear Stock Lockers
- 115 TA-50 Military Gear Storage Lockers
- 116 SecurityMax All-Welded High Security Lockers
- 117 Black Tie Office Space Commercial Lockers
- 118 PE/Gym All-Welded Stock Lockers
- 120 24/7 Parcel Lockers
- 122 Bulk Storage Lockers (BSL)



LOCKERS: PRODUCTION (NON-STOCK)

- 124 Recruiter Custom Wood Lockers
- 126 Metal Cubbies
- 127 Open-Front All-Welded Gear Lockers
- 128 Unibody All-Welded Lockers
- 131 Equipment & Premium Lockers
- 132 Premium KD Box & Specialty Lockers
- 134 Heavy-Duty Corridor Lockers (HDC)
- 134 Heavy-Duty Ventilated Lockers (HDV)
- 135 Locker Accessories
- 136 Locks
- 137 Bench Tops & Pedestals
- 138 Phenolic & Plastic Color Chart
- 139 Color Selector for Production (non-stock) lockers



ADVANTAGES OF SIX DISTRIBUTION CENTERS

- ✓ **REDUCES FREIGHT COST**
- ✓ **REDUCES TRANSIT TIME**
- ✓ **MINIMIZES CARRIER HANDLING**

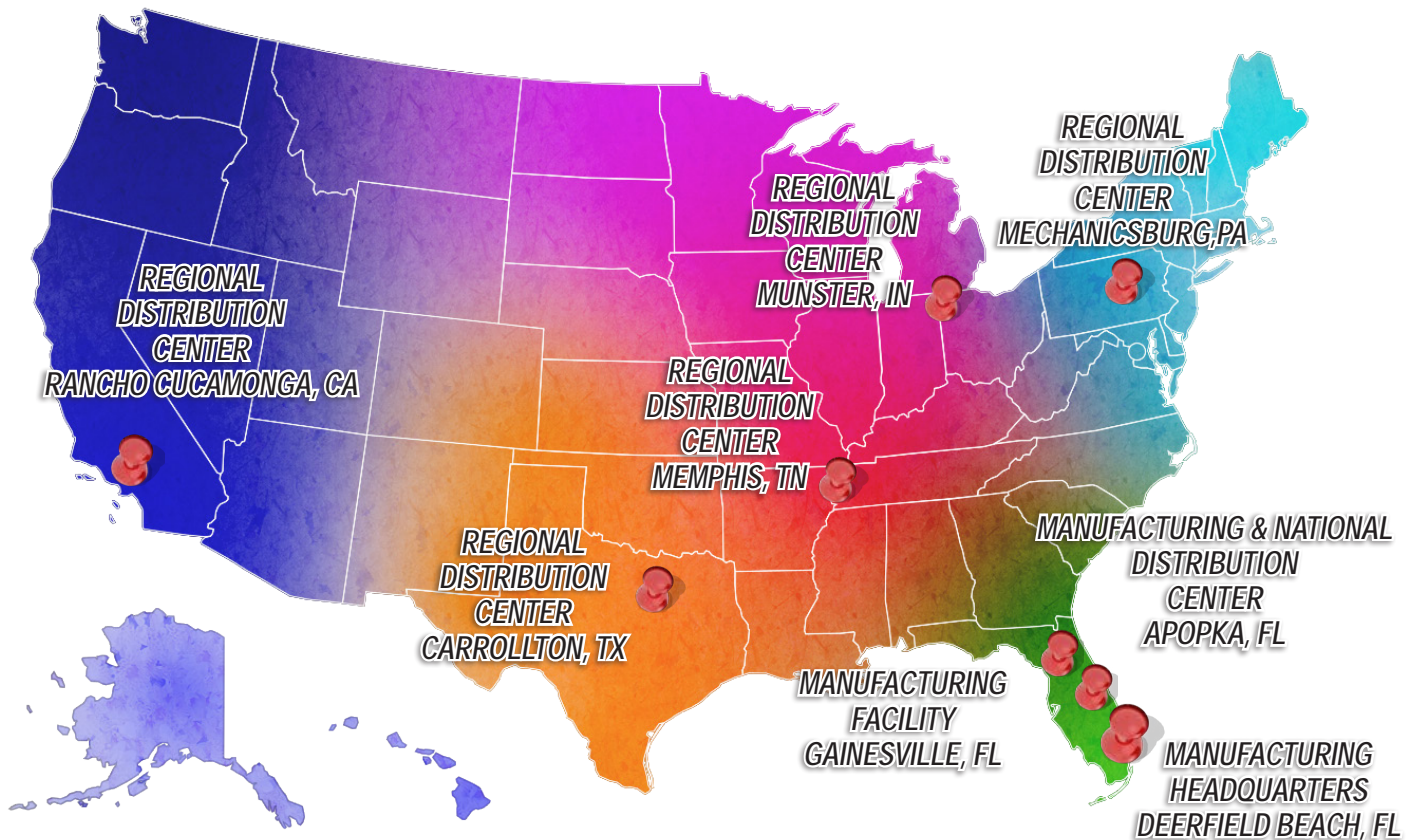

QUICK-SHIP BENEFITS

- ✓ **NO SETUP CHARGES**
- ✓ **NO MINIMUM ORDER QUANTITY**
- ✓ **INDUSTRY'S BEST DISCOUNT**

CALL **866-566-0500** FOR MORE INFORMATION ON OUR QUICK-SHIP PROGRAM

THE FASTEST SHIPPING WITH THE MOST SECURE PACKAGING

In an industry where damage in transit can be difficult to prevent, Hallowell goes the extra mile to ensure your purchase is protected by providing the industry's best packaging materials and techniques.



1. Pallet is sized to fit unit with no overhang and with bottom protection

2. Full height corner guards and Top cap are added.

3. Outside faces are protected

4. Extra packing is added to protect handles when projecting and the units are wrapped with poly wrap and double strapped in two directions to ensure stability.

KNOCK-DOWN SHIPMENTS

- All components are packaged in custom designed corrugated cartons
- Pallets are sized so that no material overhangs the pallet
- All cartons are securely strapped to pallets

FULLY-ASSEMBLED SHIPMENTS

- Pallets are sized so that no part of a unit overhangs the pallet
- When two units share a pallet, the inward facing locker fronts are separated by corrugated spacers
- Locker tops and bottoms are protected by specially designed capping cartons
- Outside corners are protected with heavy-duty full height corner guards
- Perimeter surfaces are protected with full height corrugated sheets
- Locker fronts always face the center of a pallet when possible
- Units are wrapped with Heavy-gauge clear poly wrap
- Units are double strapped in two directions to ensure maximum stability



Palletized Knock-Down Lockers



Palletized Assembled Lockers



Palletized Assembled Cabinets



Palletized BSL



Palletized Shelving (Stock)

INDUSTRY'S BEST PACKAGING

RIVETWELL™

Boltless shelving is designed to maximize storage space and minimize installation set-up time.

All components are engineered to attach snugly to one another without the use of loose fasteners. This unique design has rivets which are factory attached to all left-to-right and front-to-back beams. The rivets align with keyhole slots in the vertical posts. Once tapped into place using a standard rubber mallet, the units are tightly assembled providing maximum strength.

Standard units consist of vertical angle posts at the corners, double rivet angle beams at the top and bottom perimeter and single rivet angle beams running left-to-right only at the intermediate levels. Shelves are of standard 5/8" particle board, EZ-Deck steel or wire decking and simply drop into place. Shelf strength can be increased by upgrading to heavy duty beams, adding single rivet beams running front-to-back at the intermediate levels, upgrading to double rivet beams at the full perimeter of the intermediate levels or upgrading all levels to our strongest double rivet channel beams. Optional center supports can be added using supplied hardware to increase decking capacity.

The versatility of our Rivetwell boltless shelving system allows you to mix and match components to meet your unique application. From standard storage applications, record storage to automotive tire racks, Rivetwell boltless shelving is your storage solution.



729
TAN (PT)

708
BLACK (ME)

- All units/components available in Tan
- Select units/components available in Black
- See charts for stock availability of Tan or Black

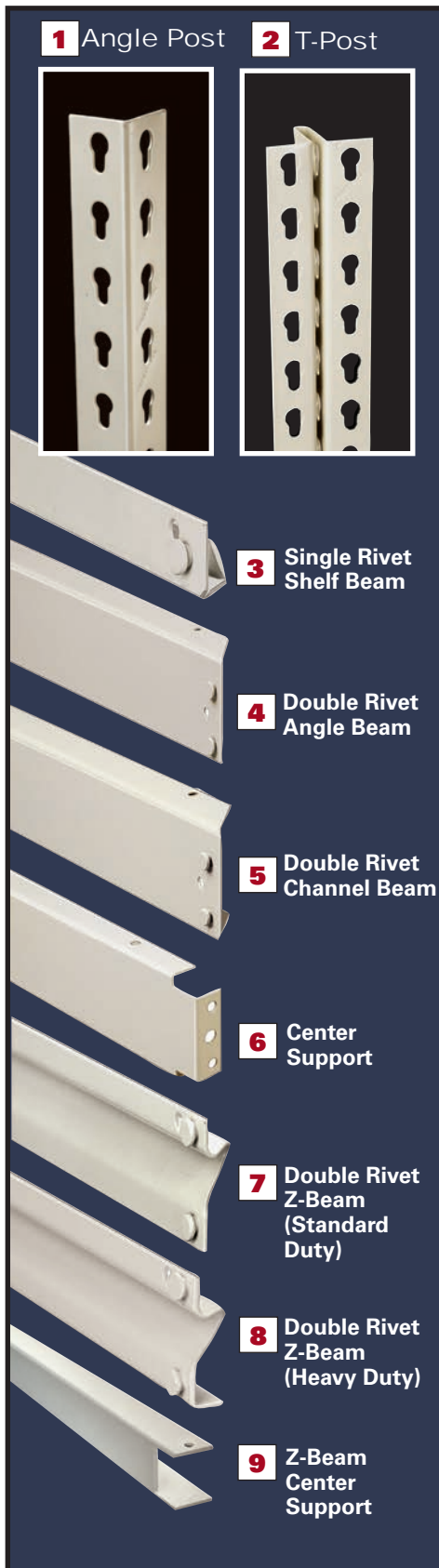

1 Angle Post (Standard Duty): 1-1/2" x 1-1/2" x 14 gauge cold rolled steel corner post uprights. Perfect for standard load situations.

Angle Post (Heavy Duty): Shall be 1-7/8" x 1-7/8" x 14 gauge cold rolled steel uprights. The choice when heavy duty shelving is required. Perfect for multilevel installations.

2 T-Post (Standard Duty): 3" x 1-7/8" x 14 gauge cold rolled steel intermediate uprights.

T-Post (Heavy Duty): 3-3/4" x 1-7/8" x 14 gauge cold rolled steel intermediate uprights.

3 Single Rivet Shelf Beam (Standard Duty): This 14 gauge low profile standard intermediate level shelf beam is perfect when maximum clear opening is required between shelf levels.

Single Rivet Shelf Beam (Heavy Duty): An 11 gauge heavy duty version of our low profile intermediate shelf beam allowing maximum clear opening between shelf levels.

4 Double Rivet Angle Beam (Standard Duty): This 16 gauge shelf beam is essential for stability of standard units; therefore, is used on all four sides at the top and bottom levels. Can also be used front and back or on all four sides of intermediate levels to increase unit stability and load capacity.

Double Rivet Angle Beam (Heavy Duty): An upgrade to our standard duty double rivet angle beams, our heavy duty double rivet angle beams provide additional unit rigidity and even higher shelf capacity.

5 Double Rivet Channel Beam: Maximized left-to-right shelf capacity is achieved using our 14 gauge double rivet channel beams in lieu of double rivet angle beams. These beams cannot be used at the bottom level.

6 Center Support: Used to provide additional shelf support front-to-back by bolting between double rivet beams at pre-punched locations. Ideal for wider spans.

7 Double Rivet Z-Beam (Standard Duty): For 12" thru 60" beams. Used in place of double rivet angle beams to add 1" additional clearance between shelf levels. Allows particle board decking to sit flush with beam. Protects decking edges. When used at bottom level of single rivet units, shelf clearance is increased by 1" at lower level. Standard Z beams are 14 gauge.

8 Double Rivet Z-Beam (Heavy Duty): For 69" and 72" beams. Used in place of double rivet angle beams to add 1" additional clearance between shelf levels. Allows particle board decking to sit flush with beam. Protects decking edges. Heavy-Duty Z beams are 14 gauge

9 Center Support for Z-Beam: Used with Z-Beams for front to back decking support. Fabricated of 11 gauge cold rolled steel.

UNIT GROWTH CHART

When designing a shelving layout, unit growth must be considered. To determine the overall dimension of a continuous row of shelving employing T-Posts or Angle Posts with tie plates, refer to the table below.

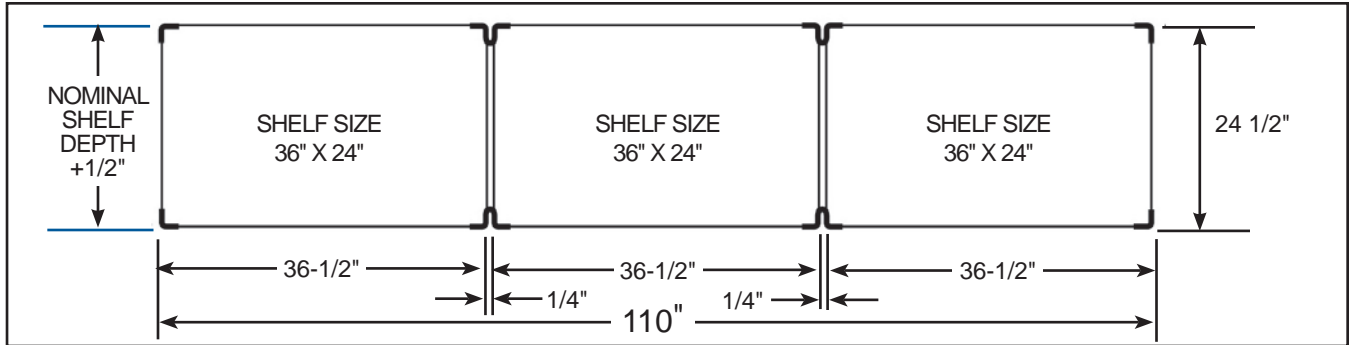

Unit Clear Width

Examples below are based on 36" wide shelf.

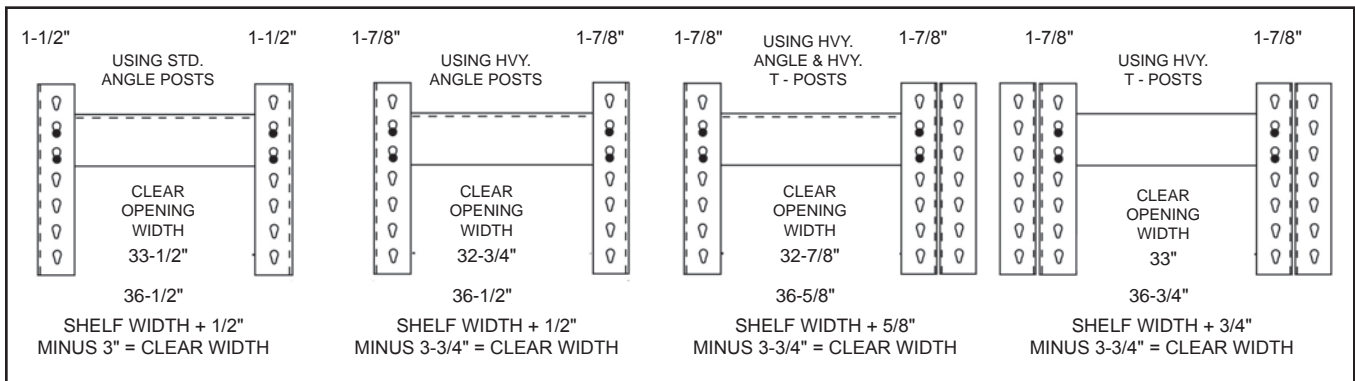

Vertical Shelf Clearance for Single Rivet Units

This chart depicts shelf clearances for typical rivetwell shelving units with 1-1/2" vertical shelf adjustment

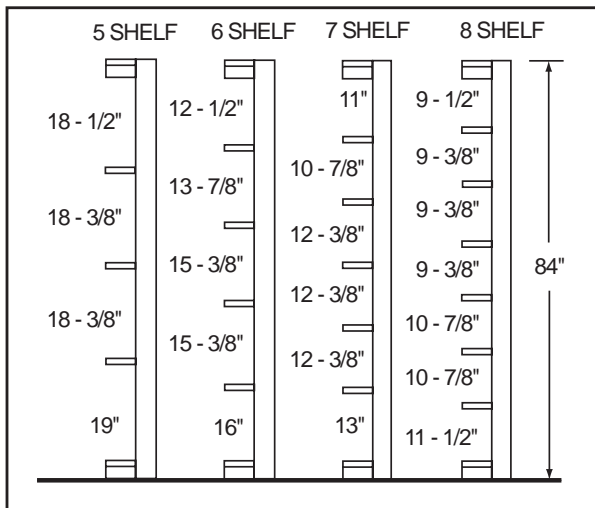

Vertical Shelf Clearance for Double Rivet units

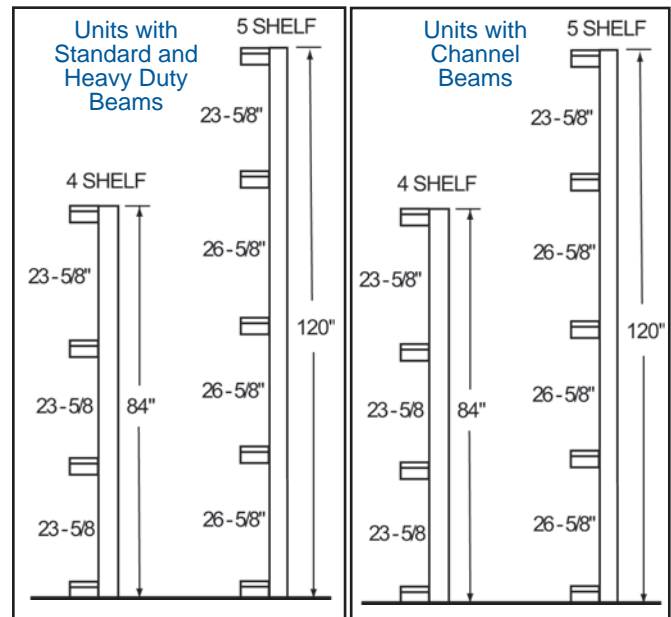

SINGLE RIVET UNITS - 84" HIGH

36" Wide Units					48" Wide Units			
(Decking not included)					(Decking not included)			
Levels	Depth	Shelf Capacity	Starter Model No.	Adder Model No.	Shelf Capacity	Starter Model No.	Adder Model No.	Color Selection
5 Shelf	12	350	SRS361284-5S	SRS361284-5A	250	SRS481284-5S	SRS481284-5A	PT
Units	18	350	SRS361884-5S	SRS361884-5A	250	SRS481884-5S	SRS481884-5A	PT
	24	350	SRS362484-5S	SRS362484-5A	250	SRS482484-5S	SRS482484-5A	PT
	30	350	SRS363084-5S	SRS363084-5A	250	SRS483084-5S	SRS483084-5A	PT
	36	350	SRS363684-5S	SRS363684-5A	250	SRS483684-5S	SRS483684-5A	PT
6 Shelf	12	350	SRS361284-6S	SRS361284-6A	250	SRS481284-6S	SRS481284-6A	PT
Units	18	350	SRS361884-6S	SRS361884-6A	250	SRS481884-6S	SRS481884-6A	PT
	24	350	SRS362484-6S	SRS362484-6A	250	SRS482484-6S	SRS482484-6A	PT
	30	350	SRS363084-6S	SRS363084-6A	250	SRS483084-6S	SRS483084-6A	PT
	36	350	SRS363684-6S	SRS363684-6A	250	SRS483684-6S	SRS483684-6A	PT
7 Shelf	12	350	SRS361284-7S	SRS361284-7A	250	SRS481284-7S	SRS481284-7A	PT
Unit	18	350	SRS361884-7S	SRS361884-7A	250	SRS481884-7S	SRS481884-7A	PT
	24	350	SRS362484-7S	SRS362484-7A	250	SRS482484-7S	SRS482484-7A	PT
	30	350	SRS363084-7S	SRS363084-7A	250	SRS483084-7S	SRS483084-7A	PT
	36	350	SRS363684-7S	SRS363684-7A	250	SRS483684-7S	SRS483684-7A	PT
8 Shelf	12	350	SRS361284-8S	SRS361284-8A	250	SRS481284-8S	SRS481284-8A	PT
Unit	18	350	SRS361884-8S	SRS361884-8A	250	SRS481884-8S	SRS481884-8A	PT
	24	350	SRS362484-8S	SRS362484-8A	250	SRS482484-8S	SRS482484-8A	PT
	30	350	SRS363084-8S	SRS363084-8A	250	SRS483084-8S	SRS483084-8A	PT
	36	350	SRS363684-8S	SRS363684-8A	250	SRS483684-8S	SRS483684-8A	PT

Starter units consist of four standard angle posts, four left-to-right standard double rivet angle beams, four front-to-back standard double rivet angle beams, two left-to-right standard single rivet beams per intermediate level and two front-to-back standard single rivet beam at one intermediate level only (30" and 36" deep units include two front-to-back single rivet beams at each intermediate level).

Adder units consist of two standard T-Posts, four left-to-right standard double rivet angle beams, two front-to-back standard double rivet angle beam, two left-to-right standard single rivet beam per intermediate level and one front-to-back standard single rivet beam at one intermediate level only (30" and 36" deep units include one front-to-back single rivet beam at each intermediate level).

Be sure to order one each of Wire or Particle board decking per level.

See page 15-16 for decking options (sold separately) EZ-Deck steel decking can NOT be used on single rivet units.



Standard 5-shelf single rivet starter unit (order decking separately)

DOUBLE RIVET UNITS - 84" HIGH WITH 4 LEVELS

Width	Beam Type	Depth	Without Center Support (Decking Not Included)				With Center Support (Decking Not Included)			Color Selection
			Shelf Cap	Starter Model No.	Adder Model No.	Shelf Cap	Starter Model No.	Adder Model No.		
48"	Heavy-Duty Angle	18	750	DRH481884-4S	DRH481884-4A	1400	DRHC481884-4S	DRHC481884-4A	PT, ME	
		24	750	DRH482484-4S	DRH482484-4A	1400	DRHC482484-4S	DRHC482484-4A	PT, ME	
		30	750	DRH483084-4S	DRH483084-4A	1310	DRHC483084-4S	DRHC483084-4A	PT, ME	
		36	750	DRH483684-4S	DRH483684-4A	1220	DRHC483684-4S	DRHC483684-4A	PT, ME	
		48	750	DRH484884-4S	DRH484884-4A	1125	DRHC484884-4S	DRHC484884-4A	PT, ME	
60"	Heavy-Duty Angle Beam	18	600	DRH601884-4S	DRH601884-4A	1200	DRHC601884-4S	DRHC601884-4A	PT, ME	
		24	600	DRH602484-4S	DRH602484-4A	1200	DRHC602484-4S	DRHC602484-4A	PT, ME	
		30	600	DRH603084-4S	DRH603084-4A	1200	DRHC603084-4S	DRHC603084-4A	PT, ME	
		36	600	DRH603684-4S	DRH603684-4A	1200	DRHC603684-4S	DRHC603684-4A	PT, ME	
		48	600	DRH604884-4S	DRH604884-4A	1200	DRHC604884-4S	DRHC604884-4A	PT, ME	
60"	Channel Beam	18	-	-	-	2000	DRCC601884-4S	DRCC601884-4A	PT	
		24	-	-	-	2000	DRCC602484-4S	DRCC602484-4A	PT	
		30	-	-	-	2000	DRCC603084-4S	DRCC603084-4A	PT	
		36	-	-	-	2000	DRCC603684-4S	DRCC603684-4A	PT	
		48	-	-	-	2000	DRCC604884-4S	DRCC604884-4A	PT	
72"	Heavy-Duty Angle Beam	18	500	DRH721884-4S	DRH721884-4A	1000	DRHC721884-4S	DRHC721884-4A	PT, ME	
		24	500	DRH722484-4S	DRH722484-4A	1000	DRHC722484-4S	DRHC722484-4A	PT, ME	
		30	500	DRH723084-4S	DRH723084-4A	1000	DRHC723084-4S	DRHC723084-4A	PT, ME	
		36	500	DRH723684-4S	DRH723684-4A	1000	DRHC723684-4S	DRHC723684-4A	PT, ME	
		48	500	DRH724884-4S	DRH724884-4A	1000	DRHC724884-4S	DRHC724884-4A	PT, ME	
72"	Channel Beam	18	-	-	-	1850	DRCC721884-4S	DRCC721884-4A	PT	
		24	-	-	-	1850	DRCC722484-4S	DRCC722484-4A	PT	
		30	-	-	-	1850	DRCC723084-4S	DRCC723084-4A	PT	
		36	-	-	-	1850	DRCC723684-4S	DRCC723684-4A	PT	
		48	-	-	-	1850	DRCC724884-4S	DRCC724884-4A	PT	
96"	Heavy-Duty Angle Beam	18	-	-	-	620	DRHC961884-4S	DRHC961884-4A	PT, ME	
		24	-	-	-	620	DRHC962484-4S	DRHC962484-4A	PT, ME	
		30	-	-	-	620	DRHC963084-4S	DRHC963084-4A	PT, ME	
		36	-	-	-	620	DRHC963684-4S	DRHC963684-4A	PT, ME	
		48	-	-	-	620	DRHC964884-4S	DRHC964884-4A	PT, ME	
96"	Channel Beam	18	-	-	-	1400	DRCC961884-4S	DRCC961884-4A	PT	
		24	-	-	-	1400	DRCC962484-4S	DRCC962484-4A	PT	
		30	-	-	-	1400	DRCC963084-4S	DRCC963084-4A	PT	
		36	-	-	-	1400	DRCC963684-4S	DRCC963684-4A	PT	
		48	-	-	-	1400	DRCC964884-4S	DRCC964884-4A	PT	

DOUBLE RIVET UNITS - 120" HIGH WITH 5 LEVELS

72"	Heavy-Duty Angle Beam	30	500	DRH7230120-5S	DRH7230120-5A	1000	DRHC7230120-5S	DRHC7230120-5A	PT
		36	500	DRH7236120-5S	DRH7236120-5A	1000	DRHC7236120-5S	DRHC7236120-5A	PT
		48	500	DRH7248120-5S	DRH7248120-5A	1000	DRHC7248120-5S	DRHC7248120-5A	PT
72"	Channel Beam	30	-	-	-	1490	DRCC7230120-5S	DRCC7230120-5A	PT
		36	-	-	-	1490	DRCC7236120-5S	DRCC7236120-5A	PT
		48	-	-	-	1490	DRCC7248120-5S	DRCC7248120-5A	PT
96"	Heavy-Duty Angle Beam	30	-	-	-	620	DRHC9630120-5S	DRHC9630120-5A	PT
		36	-	-	-	620	DRHC9636120-5S	DRHC9636120-5A	PT
		48	-	-	-	620	DRHC9648120-5S	DRHC9648120-5A	PT
96"	Channel Beam	30	-	-	-	1400	DRCC9630120-5S	DRCC9630120-5A	PT
		36	-	-	-	1400	DRCC9636120-5S	DRCC9636120-5A	PT
		48	-	-	-	1400	DRCC9648120-5S	DRCC9648120-5A	PT

Starter units consist of four standard angle posts, two left-to-right standard double rivet angle/channel beams per level and two front-to-back standard double rivet angle beams per level.

Adder units consist of two standard T-Posts, two left-to-right standard double rivet angle/channel beams per level and two front-to-back standard double rivet angle beams per level. Channel beam units are provided with left-to-right double rivet angle beams at bottom level.

See pages 15-16 for decking options (sold separately)

RECORD STORAGE UNITS							
Width	Depth	Height	Levels	*No. of boxes	Starter Model No.	Adder Model No.	Color Selection
42"	15"	60"	3	18	RS421560-3S	RS421560-3A	PT
	30"	60"	3	36	RS423060-3S	RS423060-3A	PT
69"	15"	60"	3	30	RS691560-3S	RS691560-3A	PT
	30"	60"	3	60	RS693060-3S	RS693060-3A	PT
42"	15"	84"	4	24	RS421584-4S	RS421584-4A	PT
	30"	84"	4	48	RS423084-4S	RS423084-4A	PT
69"	15"	84"	4	40	RS691584-4S	RS691584-4A	PT
	30"	84"	4	80	RS693084-4S	RS693084-4A	PT
42"	15"	108"	5	30	RS4215108-5S	RS4215108-5A	PT
	30"	108"	5	60	RS4230108-5S	RS4230108-5A	PT
69"	15"	108"	5	50	RS6915108-5S	RS6915108-5A	PT
	30"	108"	5	100	RS6930108-5S	RS6930108-5A	PT

Be sure to order one each of particle board or EZ-Deck steel decking per level.

See pages 15-16 for decking options (sold separately)

*Box count based on standard record storage box dimensions: 12 x 10 x 15
Record storage boxes are not included

ACCESS UNIT FROM
FRONT OR BACK!



Record Storage Unit
with 4 levels
(80 Box unit)

RIVETWELL™ SHELVING

TIRE STORAGE RACKS

Width	Depth	Height	Levels	*Tire Capacity	Starter Model No.	Adder Model No.
SINGLE ROW						
60"	21"	84"	3	24	TSS602184-3S	TSS602184-3A
	21"	120"	4	32	TSS6021120-4S	TSS6021120-4A
	21"	144"	5	40	TSS6021144-5S	TSS6021144-5A
	21"	192"	6	48	TSS6021192-6S**	TSS6021192-6A**
DOUBLE ROW						
60"	42"	84"	3	48	TSD602184-3S	TSD602184-3A
	42"	120"	4	64	TSD6021120-4S	TSD6021120-4A
	42"	144"	5	80	TSD6021144-5S	TSD6021144-5A
	42"	192"	6	96	TSD6021192-6S**	TSD6021192-6A**

(*Based on average passenger tire (** Supplied with heavy-duty posts

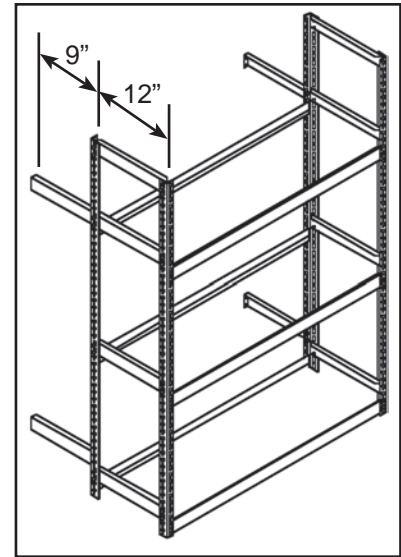

Tire Storage Rack

MUFFLER STORAGE UNITS

Width	Depth	Height	Levels	Starter Model No.	Adder Model No.
48"	36"	84"	5	MS483684-5S	MS483684-5A
96"	36"	84"	5	MS963684-5S	MS963684-5A

Be sure to order one each of particle board decking per level.

HANGING TAILPIPE RACK

Width	Depth	Height	Starter Model No.
48"	18"	120"	HTP4818120
96"	18"	120"	HTP9618120

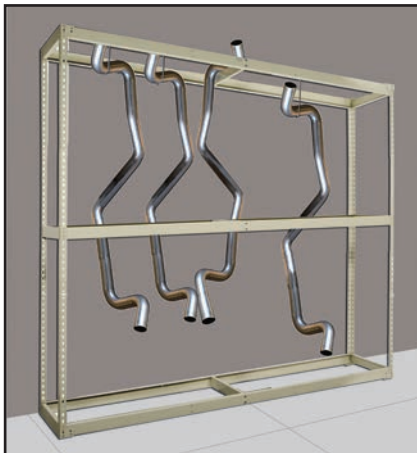

Hanging Tailpipe Rack



Tire Rack



Muffler Storage Rack



729
TAN (PT)

RIVETWELL SHELVING COMPONENTS

PART DESCRIPTION	HEIGHT	STANDARD PART NO.	HEAVY-DUTY PART NO.
ANGLE POST		1-1/2" x 1-1/2" (14 ga)	1-7/8" x 1-7/8" (14 ga)
Punched for self adjustment on 1-1/2" centers	3'	APS03	-
	4'	APS04	-
	5'	• APS05	-
	6'	• APS06	APH06
	7'	•• APS07	APH07
	8'	• APS08	APH08
	9'	• APS09	APH09
	10'	• APS10	APH10
	12'	APS12	APH12
	14'	APS14	APH14
16'	APS16	APH16	

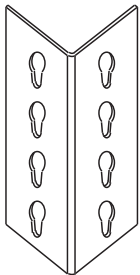

Note: For requirements above 10'-0" high, multiple posts can be spliced using PS05 post splice without compromising capacity.

T-POST	HEIGHT	STANDARD PART NO.	HEAVY-DUTY PART NO.
		3" x 1-7/8" (14 ga)	3-3/4" x 1-7/8" (14 ga)
Punched for self adjustment on 1-1/2" centers	3'	TPS03	TPH03
	4'	TPS04	TPH04
	5'	• TPS05	TPH05
	6'	• TPS06	TPH06
	7'	•• TPS07	TPH07
	8'	• TPS08	TPH08
	9'	• TPS09	TPH09
	10'	• TPS10	TPH10
	12'	TPS12	TPH12
	14'	TPS14	TPH14
16'	TPS16	TPH16	

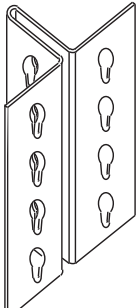

Note: For requirements above 10'-0" high, multiple posts can be spliced using PS05 post splice without compromising capacity.

PART DESCRIPTION	LENGTH	STANDARD PART NO.	HEAVY-DUTY PART NO.
DOUBLE RIVET ANGLE BEAM		2-3/4" x 1" (16 ga)	2-3/4" x 1" (14 ga)
For left to right and front to back shelf support.	12"	• ABS12	-
	15"	• ABS15	-
	18"	•• ABS18	-
	24"	•• ABS24	-
	30"	•• ABS30	-
	32"	ABS32	-
	36"	•• ABS36	-
	42"	• ABS42	-
	48"	-	•• ABH48
	60"	-	•• ABH60
	69"	-	• ABH69
	72"	-	•• ABH72
	84"	-	ABH84
96"	-	•• ABH96	

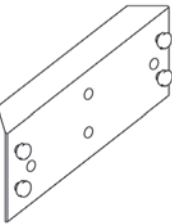

Denotes Stock Component

- Denotes stock item in 729 Tan (PT)
- Denotes stock item in 729 Tan (PT) and 708 Black (ME)

PART DESCRIPTION	LENGTH	STANDARD PART NO.	HEAVY-DUTY PART NO.
DOUBLE RIVET CHANNEL BEAM			1" x 2-3/4" (14 ga)
For left to right shelf support. Provides for a higher capacity than heavy-duty rivet angle beams.	48"	-	• CBH48
	60"	-	• CBH60
	69"	-	• CBH69
	72"	-	• CBH72
	84"	-	• CBH84
	96"	-	• CBH96

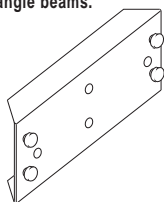

Note: When a bottom shelf is required to be at the bottom level, use a Heavy-Duty Double Rivet Angle Beam.

SINGLE RIVET BEAM	LENGTH	STANDARD PART NO.	HEAVY-DUTY PART NO.
		1" x 2-1/2" (14 ga)	1" x 1-1/4" x 7/8" (11 ga)
For use as left to right and front to back support. See Beam Load Table for capacity.	12"	• SRBS12	-
	15"	SRBS15	-
	18"	• SRBS18	-
	24"	• SRBS24	-
	30"	• SRBS30	-
	36"	• SRBS36	SRBH36
	42"	• SRBS42	SRBH42
	48"	• SRBS48	SRBH48

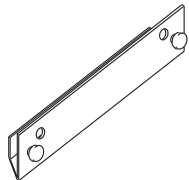

CENTER SUPPORT	LENGTH	STANDARD PART NO.	HEAVY-DUTY PART NO.
		2-3/4" x 1" x 1" (16 ga)	
Bolts to double rivet angle or channel beams to add support to decking and stabilize beams. Supplied with nuts and bolts for fast assembly. Use 1 per pair of beams up to 84", 2 per pair of 96" beams.	12"	• CS12	-
	15"	• CS15	-
	18"	•• CS18	-
	24"	•• CS24	-
	30"	•• CS30	-
	32"	CS32	-
	36"	•• CS36	-
	42"	CS42	-
	48"	•• CS48	-

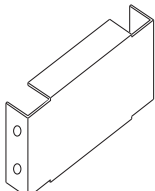

DOUBLE ROW AND TOP TIE	LENGTH	STANDARD PART NO.	HEAVY-DUTY PART NO.
		2-1/2" x 1/4" (14 ga)	
Use to space back-to-back units and to top-tie rows across aisle for added stability.	9-1/4"	-	DRTT09
	12-1/4"	-	DRTT12
	15-1/4"	-	DRTT15
	18-1/4"	-	• DRTT18
	24-1/4"	-	DRTT24
	36-1/4"	-	DRTT36
	42-1/4"	-	DRTT42
	48-1/4"	-	DRTT48

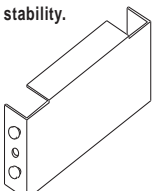

729
TAN (PT)

708
BLACK (ME)

PART DESCRIPTION	LENGTH	STANDARD PART NO.	HEAVY-DUTY PART NO.
WALL TIE		2-1/2" x 1-1/4" (14 ga)	

Used to secure units to wall and provide space between wall and unit (Hardware to attach to wall not included).

9-1/4"

• **WT09**

-

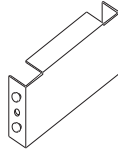

PART DESCRIPTION	LENGTH	STANDARD PART NO.	HEAVY-DUTY PART NO.
FOOT PLATE		1-1/2" x 1-1/2" x 3" (14 ga)	

For use in anchoring angle and tee posts to floor. (Hardware included for attaching posts-Hardware to anchor to the floor not included.) anchor holes are 3/8" diameter.

3"

• **FPR100**

-

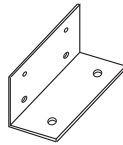

PART DESCRIPTION	LENGTH	STANDARD PART NO.	HEAVY-DUTY PART NO.
POST SPLICE		1-3/8" x 1-3/8" x 5" (11 ga)	

Used to extend post, attaches to outside of post. Order one per Angle Post, two per T-Post.

5"

• **PS05**

-



PART DESCRIPTION	LENGTH	STANDARD PART NO.	HEAVY-DUTY PART NO.
TIE PLATE		3" x 3" (14 ga)	

Used for structural integrity of T-Post and to join Angle Post units side by side to insure proper row alignment.

NA

• **TP1**

-



PART DESCRIPTION	LENGTH	STANDARD PART NO.	HEAVY-DUTY PART NO.
TIRE RACK BEAM		3" x 3" (14 ga)	

For left to right shelf support of tires. 9 degrees of angle on the supporting edge.

48"

TRB48

-

60"

• **TRB60**

-

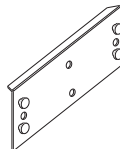

PART DESCRIPTION	LENGTH	STANDARD PART NO.	HEAVY-DUTY PART NO.
HANGER BAR		1-1/4" x 1-1/4" x 1-1/4" (14 ga)	

For hanging items between double rivet beams. One or more may be used per level.

36"

HB 36

-

42"

HB 42

-

48"

HB 48

-

60"

HB 60

-

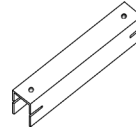

PART DESCRIPTION	LENGTH	STANDARD PART NO.	HEAVY-DUTY PART NO.
DECK OVER GRATING SUPPORT		3-12" x 1-13/16" x 2-3/16" (11 ga)	

Provides secure support for grating when decking over entire installation.

36"

-

DOGS36

48"

-

DOGS48

60"

-

DOGS60

69"

-

DOGS69

72"

-

DOGS72

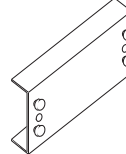

PART DESCRIPTION	LENGTH	STANDARD PART NO.	HEAVY-DUTY PART NO.
DOWN AISLE GRATING SUPPORT		3-12" X 1-13/16" X 1-15/16" (11 ga)	

Attaches to unit front between rows to provide support for grating on 2-level rivetwell installations. For maximum aisle width of 48". Use a minimum of 3 screws per support. 9 degree angle on top edge.

36"

-

DAGS36

48"

-

DAGS48

60"

-

DAGS60

69"

-

DAGS69

72"

-

DAGS72

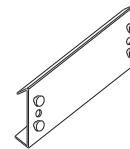

PART DESCRIPTION	LENGTH	LEFT PART NO.	RIGHT PART NO.
BEAM CLEAT		1-1/2" x 1"-1/2" x 3" (14 ga)	

For hanging items between double rivet beams. One or more may be used per level.

3"

BC-L

BC-R

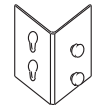
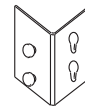

PART DESCRIPTION	LENGTH	STANDARD PART NO.	HEAVY-DUTY PART NO.
SLOTTED ANGLE CLEAT		1-1/2" x 1"-1/2" x 3" (14 ga)	

For use where slotted angle pieces must be joined, such as special grating supports and top ties.

3"

SAC-L

SAC-R



729
TAN (PT)

708
BLACK (ME)

Denotes Stock Component
• Denotes stock item in 729 Tan (PT)

PART DESCRIPTION	LENGTH	STANDARD PART NO.	HEAVY-DUTY PART NO.
DOUBLE RIVET Z-BEAM (STANDARD) 2-1/8" x 7/8" (14 ga)			
For front to back and left to right. allows particle board decking to sit flush with top of beam.	12"	ZBS12	-
	15"	ZBS15	-
	18"	ZBS18	-
	24"	ZBS24	-
	30"	ZBS30	-
	36"	ZBS36	-
	42"	ZBS42	-
	48"	ZBS48	-
	60"	ZBS60	-

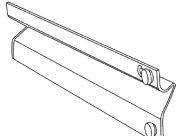

PART DESCRIPTION	LENGTH	STANDARD PART NO.	HEAVY-DUTY PART NO.
DOUBLE RIVET Z-BEAM (HEAVY-DUTY) 2-1/8" x 7/8" (14 ga)			
For front to back and left to right. Allows particle board decking to sit flush with top of beam.	48"	-	ZBH48
	60"	-	ZBH60
	69"	-	ZBH69
	72"	-	ZBH72

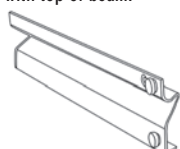

PART DESCRIPTION	LENGTH	STANDARD PART NO.	HEAVY-DUTY PART NO.
CENTER SUPPORT FOR Z-BEAMS 1-3/16" X 1-1/8" X 7/8" (11 GA)			
Use with Z-beams for additional decking support front to back.	24"	ZCS24	-
	30"	ZCS30	-
	36"	ZCS36	-
	42"	ZCS42	-
	48"	ZCS48	-



PART DESCRIPTION	LENGTH	STANDARD PART NO.	HEAVY-DUTY PART NO.
COAT ROD SUPPORT BEAM 2-3/4" X 1" (14 ga)			
For supporting Rivetwell coat rods	18"	ABH18CR	-
	24"	ABH24CR	-
	30"	ABH30CR	-
	36"	ABH36CR	-
	48"	ABH48CR	-

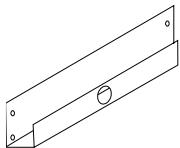

PART DESCRIPTION	LENGTH	STANDARD PART NO.	HEAVY-DUTY PART NO.
RIVETWELL COAT ROD 1' O.D. SCH40 Steel Pipe			
For use with coat rods and support beams	36"	RCR36	-
	48"	RCR48	-
	60"	RCR60	-
	72"	RCR72	-



RED COLOR Denotes Stock Component

Rivetwell Flat Wire Decking



4 gauge wire in 2" x 4" pattern.

Part Number	Size (inches) W x D	Wire Supports	*Capacity (Lbs)
All decks are Powder Coated Gray.			
HWD3618	36" x 18"	4	725
HWD3624	36" x 24"	4	605
HWD3630	36" x 30"	4	485
HWD3636	36" x 36"	4	455
HWD3648	36" x 48"	4	300
HWD4818	48" x 18"	5	725
HWD4824	48" x 24"	5	605
HWD4830	48" x 30"	5	485
HWD4836	48" x 36"	5	455
HWD4848	48" x 48"	5	300
HWD6018	60" x 18"	6	725
HWD6024	60" x 24"	6	605
HWD6030	60" x 30"	6	485
HWD6036	60" x 36"	6	455
HWD6048	60" x 48"	6	300

All sizes measure 1/8" short of nominal dimension in both directions.

*Capacities are based on evenly distributed loads and Include a 1.65 safety factor.

RIVETWELL™ SHELVING COMPONENTS

Recommended safe use load table for 5/8" particle board and EZ-Deck steel decking allowable uniformly distributed static live loads for deck material

Size (inches) W x D	Particle Board Decking	EZ-Deck Steel Decking	2 Sides Supported		4 Sides Supported		4 Sides + Center Supported		4 Sides + 2 Center Supported	
			LOAD (lbs.)	DEFL (ins)	LOAD (Lbs.)	DEFL (ins)	LOAD (Lbs.)	DEFL (ins)	LOAD (Lbs.)	DEFL (ins)
36x12	HPB3612	HEZD3612	425	0.06	675	0.08				
36x18	HPB3618	HEZD3618	400	0.17	550	0.18				
36x24	HPB3624	HEZD3624	305	0.30	435	0.23				
36x30	HPB3630	HEZD3630	250	0.47	385	0.32				
36x36	HPB3636	HEZD3636	150	0.50	180	0.39				
42x12	HPB4212	HEZD4212	490	0.06	755	0.08				
42x18	HPB4218	HEZD4218	460	0.17	600	0.18				
42x24	HPB4224	HEZD4224	355	0.30	500	0.29				
42x30	HPB4230	HEZD4230	300	0.47	410	0.36				
42x36	HPB4236	HEZD4236	175	0.50	385	0.45				
48x12	HPB4812	HEZD4812	560	0.06	850	0.08	1160	0.08		
48x18	HPB4818	HEZD4818	525	0.17	635	0.18	770	0.10		
48x24	HPB4824	HEZD4824	405	0.30	530	0.30	700	0.11		
48x30	HPB4830	HEZD4830	325	0.47	440	0.40	705	0.12		
48x36	HPB4836	HEZD4836	200	0.50	400	0.50	755	0.12		
48x48	HPB4848	HEZD4848	85	0.50	275	0.50	920	0.13		
60x18	HPB6018	HEZD6018	660	0.17	735	0.18	835	0.12	1140	0.08
60x24	HPB6024	HEZD6024	505	0.30	615	0.32	700	0.15	1180	0.10
60x30	HPB6030	HEZD6030	410	0.47	520	0.46	650	0.16	1324	0.11
60x36	HPB6036	HEZD6036	250	0.50	380	0.50	665	0.17	1520	0.12
60x48	HPB6048	HEZD6048	105	0.50	230	0.50	750	0.18	2000	0.14
69x15	HPB6915	HEZD6915	900	0.11	950	0.12	1150	0.12	1250	0.11
69x30	HPB6930	HEZD6930	470	0.50	600	0.50	670	0.20	1220	0.13
72x18	HPB7218	HEZD7218	800	0.17	850	0.17	1000	0.15	1200	0.10
72x24	HPB7224	HEZD7224	605	0.30	680	0.31	770	0.19	1135	0.12
72x30	HPB7230	HEZD7230	500	0.47	610	0.50	680	0.21	1200	0.14
72x36	HPB7236	HEZD7236	300	0.50	390	0.50	655	0.23	1325	0.16
72x48	HPB7248	HEZD7248	130	0.50	215	0.50	685	0.25	1670	0.18
84x24	HPB8424	HEZD8424	705	0.30	765	0.31	870	0.23	1150	0.15
84x30	HPB8430	HEZD8430	570	0.47	650	0.49	735	0.27	1150	0.18
84x36	HPB8436	HEZD8436	355	0.50	415	0.50	670	0.29	1210	0.20
84x48	HPB8448	HEZD8448	150	0.50	215	0.50	660	0.33	1460	0.23
96x18	HPB9618	HEZD9618	1050	0.17	1115	0.17	1300	0.18	1500	0.15
96x24	HPB9624	HEZD9624	810	0.30	850	0.31	1000	0.26	1200	0.18
96x30	HPB9630	HEZD9630	655	0.47	710	0.49	800	0.32	1180	0.20
96x36	HPB9636	HEZD9636	405	0.50	450	0.50	710	0.36	1150	0.24
96x48	HPB9648	HEZD9648	170	0.50	200	0.50	650	0.41	1325	0.28

NOTE: The above load chart refers to the deck materials only. Particle board decking is 5/8" industrial grade type 1-M-2. EZ-Deck steel decking is 22 gauge galvanized sheet steel fabricated in 6" deep channel planks (models listed above include multiple planks to meet unit depth). 15" deep Ez-Deck will be shipped in two (2) 7 1/2" deep planks. The allowable shelf load capacity may be reduced due to allowable post and / or beam capacities. Specific deflection limits may also reduce the shelf load capacity. NOTE: EZ-Deck must be center supported on units 48" wide and wider.

Particle Board Decking

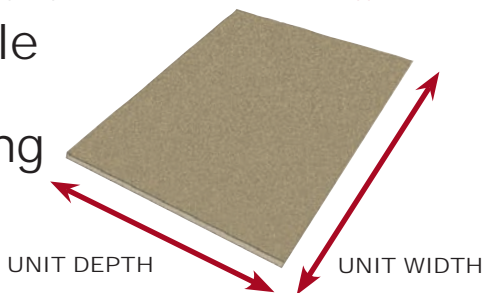

EZ-Deck Steel Decking

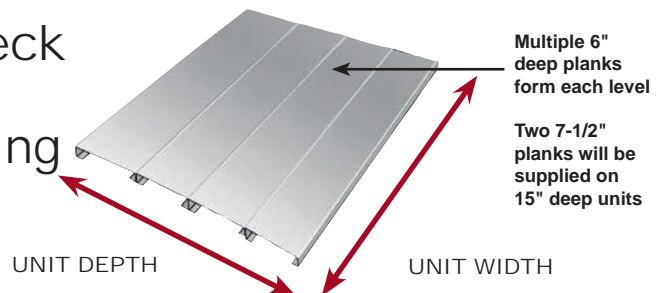

NOTE: EZ-Deck steel decking is for use with double rivet units ONLY.

POST CAPACITY CHART

Recommended safe loads (per post) for use only where seismic forces are not a factor

BEAM SPACING	STD. ANGLE POST CAPACITY	HEAVY ANGLE POST CAPACITY
12"	1530	1735
18"	1520	1720
24"	1510	1695
30"	1490	1680
36"	1350	1660
42"	990	1560
48"	755	1195

BEAM SPACING	STANDARD/HEAVY-DUTY T-POST CAPACITY
12"	5045
18"	4965
24"	4850
30"	4705
36"	4525
42"	4315
48"	4075

Calculate needed post capacity by multiplying the number of shelves by the per shelf load then divide by 4 (Angle posts), or by 2 (T-Posts) then refer to the chart below for the approximate post needed to meet your job requirement.

Post capacities are based on the maximum vertical distance between left-to-right beams or front-to-back beams, whichever is greater. In single rivet beam units, the vertical distance between front-to-back beams will usually govern. Tie plates must be spaced no more than 48 inches apart to insure structural stability when joining angle post together. All units require tie plates at top and bottom.

The above capacities are not intended for use when designing multi-level systems or for specific requirements where seismic forces are a factor. For specific multi-level or seismic requirements contact your Hallowell Sales Manager.

BEAM LOAD TABLE (CAPACITY PER PAIR)

Recommended safe use allowable uniformly distributed hand loaded static beam loads

	WITHOUT CENTER. SUPTS.(***)			WITH CENTER. SUPTS.(*)	
	LENGTH (IN.)	CAPACITY (LBS.)	DEFLECTION (IN.)	CAPACITY (LBS.)	DEFLECTION (IN.)
SINGLE RIVET SHELF BEAMS					
STANDARD BEAM	36	350	0.25	-	-
	42	300	0.30	-	-
	48	250	0.34	-	-
HEAVY DUTY BEAM	36	600	0.25	-	-
	42	550	0.30	-	-
	48	500	0.34	-	-
DOUBLE RIVET ANGLE BEAMS					
STANDARD BEAM	36	1000	***	-	-
	42	780	***	-	-
HEAVY DUTY BEAM	48	750	***	1400**	0.16
	60	600	***	1200	0.25
	69	525	***	1050	0.33
	72	500	***	1000	0.36
	84	-	-	840	0.49
	96	-	-	620	0.53
DOUBLE RIVET CHANNEL BEAMS					
	60	-	-	2240	0.23
	72	-	-	1850	0.33
	84	-	-	600	0.45
	96	-	-	1400	0.59
DOUBLE RIVET Z-BEAMS					
	48	1250	-	1750	-
	60	750	-	1000	-
	69	600	-	1000	-
	72	600	-	1000	-

DESIGN CRITERIA:

All units must have a full perimeter of double rivet beams at the top and bottom to insure a stable and rigid unit. All units using single rivet beams 10'0" to 18'0" in height, require an additional double rivet perimeter beam level located approximately in the middle of the unit.

All single rivet beam units must have one (1) intermediate pair of front to back beams for 7'0" and 8'0" high units and (2) intermediate pair of front to back beams for 9'0" high units. For 10'0" to 18'0" high units refer to the above paragraph.

DO NOT exceed 48" between front to back beams. Single Rivet and Double Rivet Front-to-Back Beams may be common when using T-Posts on units up to 8' high.

All intermediate single rivet levels over 24 inches deep must also have single rivet beams supporting the particle board front to back.

All double rivet beam units must have front to back beams at each shelf level.

(*) One (1) support per pair of beams except 96" which have two (2) supports

(**) Refer to shelf load capacities for beam capacities when depth is 30", 36", and 48"

(***) Beam rotation is less than 5 degrees

2 YEAR WARRANTY

✓ High Shelf Capacity ✓ No Cross Braces ✓ 360° Access

RIVETWELL™

HIGH CAPACITY BOLTLESS SHELVING

FEATURES:

- Shelves adjust in 1-1/2" increments
- 5 shelf levels
- Easy assembly
- Holds up to 2,300 lb. per shelf (Based on evenly distributed loads)
- Black powder coat finish
- Levels are center supported for increased capacity



FEATURES:

Angle Post (Standard-Duty): Shall be 1-1/2" x 1-1/2" x 14 gauge cold rolled steel corner post uprights.

Double Rivet Angle Beam (Standard-Duty): Shall be 2-3/4" x 1" x 16 gauge cold rolled steel. Typical for beams up to 36" in length.

Double Rivet Angle Beam (Heavy-Duty): Shall be 2-3/4" x 1" x 14 gauge cold rolled steel. An upgrade to our standard duty double rivet angle beams, our heavy duty double rivet angle beams provide additional unit rigidity and even higher shelf capacity. Typical for beams 48" long and greater.

Center Support: Shall be 2-3/4" x 1" x 1" x 16 gauge cold rolled steel. Used to provide additional shelf support front-to-back by bolting between double rivet beams at pre-punched locations.

Steel Decking: Shall be 14 gauge cold rolled sheet steel with flange formed at front and back designed to overhang left to right beams at front and back.



708
BLACK (ME)

1 YEAR WARRANTY

Width	Depth	Height	Catalog No.	Shelf Capacity
84" HIGH BOLTLESS SHELVING				
36	18	84	HCR361884-5ME	2,300
48	18	84	HCR481884-5ME	2,200
48	24	84	HCR482484-5ME	2,000
60	24	84	HCR602484-5ME	2,000
72	24	84	HCR722484-5ME	1,900
72	36	84	HCR723684-5ME	1,900
96	24	84	HCR962484-5ME	1,900
96	36	84	HCR963684-5ME	1,900
96" HIGH BOLTLESS SHELVING				
36	18	96	HCR361896-5ME	2,300
48	18	96	HCR481896-5ME	2,200
48	24	96	HCR482496-5ME	2,000
60	24	96	HCR602496-5ME	2,000
72	24	96	HCR722496-5ME	1,900
72	36	96	HCR723696-5ME	1,900
96	24	96	HCR962496-5ME	1,900
96	36	96	HCR963696-5ME	1,900

RED COLOR Denotes Stock Component

✓ High Shelf Capacity ✓ No Cross Braces ✓ 360° Access

HIGH CAPACITY DIE RACK

FEATURES:

- Shelves adjust in 1" increments
- 5 shelf levels
- Nut and bolt assembly
- Holds up to 2,800 lb. per shelf
(Based on evenly distributed loads)
- Dark Gray powder coat finish
- Shelves are reinforced to prevent deflection under heavy loading



HIGH CAPACITY DIE RACK SHELVING

FEATURES:

Angle Post: Are 13 gauge cold rolled steel 2" x 2" corner post uprights punched on 1" centers for adjusting shelves

High Capacity Shelves: Are 14 gauge cold rolled steel and double flanged at all four sides. All four corners are punched to allow shelves to be securely bolted to angle posts. Minimum four nuts and bolts per corner.

Shelf Stiffener: An 18 gauge hat channel shape stiffener is welded to the underside of the shelf running left to right increasing capacity and preventing deflection under heavy loading.

High Capacity Reinforced Bolted Shelving



Cross-section view shows Individual reinforced shelf for bolted die shelving.

Width	Depth	Height	Catalog No.	Shelf Capacity
84" HIGH BOLTED SHELVING				
36	18	84	HCS361884-5HG	2,800
48	18	84	HCS481884-5HG	2,600
48	24	84	HCS482484-5HG	2,500
60	24	84	HCS602484-5HG	2,300
72	24	84	HCS722484-5HG	2,000

RED COLOR Denotes Stock Component

**STOCK
COLOR**

725
DARK GRAY (HG)

**1 YEAR
WARRANTY**

Hi-TECH™

Hallowell Industrial Grade Steel Shelving

Hi-Tech shelving has the strength needed to handle most industrial applications and versatility for today's modern facilities. Every shelving unit is designed and engineered to meet the highest standards.

A full complement of accessories including full dividers, partial dividers, label holders, swinging doors, post splices for multilevel systems and foot plates are available to complete your system.

**3 DAY
SHIPPING
ON ALL IN-STOCK
Hi-Tech SHELVING**



725
DARK GRAY (HG)





BOX FORMED SHELVES

- Tubular welded box beam front and rear for maximum strength
- Exclusive triple bend side flanges for added strength
- Lapped and welded corners
- Top of shelf is punched to accept shelf dividers



ANGLE BACK POSTS & T-POSTS

- Roll formed into a unique angle shape for maximum strength
- The long leg is punched on 1-1/2" centers to allow independent shelf adjustment
- Angle Posts can be used in place of Beaded Front Posts if desired



BEADED FRONT POSTS

- Beaded for strength
- Flush to permit straight-in/straight-out shelf installation, shelf changing and full use of shelf width
- Punched on 1-1/2" centers to allow independent shelf adjustment



H-POSTS

- Designed for high-density applications
- More than twice the capacity of standard posts
- Used at front and back
- Used with standard Hi-Tech components



ONE PIECE SHELF CLIP

- Four sturdy and compact clips per shelf
- Keys firmly into post slots to hold shelves securely in place
- Fits Beaded Front, Angle Back Posts and T-Posts
- Non-Intrusive clip sits flush with inside edge of front posts

HI-TECH™ STEEL SHELVING

ACCESSORIES



Base Strips

Close bottom to prevent debris accumulation



Swinging Doors

Allow cabinet-style storage



Shelf Dividers

For organized storage



STARTER UNIT



ADDER UNIT



5 SHELF UNIT



6 SHELF UNIT



8 SHELF UNIT

W	D	H		5-Shelf Unit Cat No.	6-Shelf Unit Cat No.	8-Shelf Unit Cat No.	Shelf Capacity*
Medium-Duty							
36	12	87	Starter	4510-12	4511-12	4513-12	500*
36	12	87	Adder	A4510-12	A4511-12	A4513-12	500*
36	18	87	Starter	4510-18	4511-18	4513-18	500*
36	18	87	Adder	A4510-18	A4511-18	A4513-18	500*
36	24	87	Starter	4510-24	4511-24	4513-24	500*
36	24	87	Adder	A4510-24	A4511-24	A4513-24	500*
48	12	87	Starter	4710-12	4711-12	4713-12	375*
48	12	87	Adder	A4710-12	A4711-12	A4713-12	375*
48	18	87	Starter	4710-18	4711-18	4713-18	375*
48	18	87	Adder	A4710-18	A4711-18	A4713-18	375*
48	24	87	Starter	4710-24	4711-24	4713-24	350*
48	24	87	Adder	A4710-24	A4711-24	A4713-24	350*
Heavy-Duty							
36	12	87	Starter	5510-12	5511-12	5513-12	800*
36	12	87	Adder	A5510-12	A5511-12	A5513-12	800*
36	18	87	Starter	5510-18	5511-18	5513-18	800*
36	18	87	Adder	A5510-18	A5511-18	A5513-18	800*
36	24	87	Starter	5510-24	5511-24	5513-24	800*
36	24	87	Adder	A5510-24	A5511-24	A5513-24	800*
48	12	87	Starter	5710-12	5711-12	5713-12	400*
48	12	87	Adder	A5710-12	A5711-12	A5713-12	400*
48	18	87	Starter	5710-18	5711-18	5713-18	450*
48	18	87	Adder	A5710-18	A5711-18	A5713-18	450*
48	24	87	Starter	5710-24	5711-24	5713-24	500*
48	24	87	Adder	A5710-24	A5711-24	A5713-24	500*
Extra Heavy-Duty							
36	12	87	Starter	7510-12	7511-12	7513-12	1100*
36	12	87	Adder	A7510-12	A7511-12	A7513-12	1100*
36	18	87	Starter	7510-18	7511-18	7513-18	1200*
36	18	87	Adder	A7510-18	A7511-18	A7513-18	1200*
36	24	87	Starter	7510-24	7511-24	7513-24	1250*
36	24	87	Adder	A7510-24	A7511-24	A7513-24	1250*
48	12	87	Starter	7710-12	7711-12	7713-12	750*
48	12	87	Adder	A7710-12	A7711-12	A7713-12	750*
48	18	87	Starter	7710-18	7711-18	7713-18	900*
48	18	87	Adder	A7710-18	A7711-18	A7713-18	900*
48	24	87	Starter	7710-24	7711-24	7713-24	900*
48	24	87	Adder	A7710-24	A7711-24	A7713-24	900*
Additional Shelves				Medium-Duty Cat No	Heavy-Duty Cat No.	Extra Heavy-Duty Cat No.	
36	12			5135-3612	5138-3612	5139-3612	See Above
36	18			5135-3618	5138-3618	5139-3618	See Above
36	24			5135-3624	5138-3624	5139-3624	See Above
48	12			5135-4812	5138-4812	5139-4812	See Above
48	18			5135-4818	5138-4818	5139-4818	See Above
48	24			5135-4824	5138-4824	5139-4824	See Above

* Shelf capacity based on a factor of 1.65

Color for all components 725 Dark Gray. Optional colors are available at a nominal charge, additional lead times apply.

Open units: Starter units include two beaded front posts, two angle back posts, one pair back sway braces, two pair side sway braces and 5-8 shelves. Adder units include one beaded front post, two angle back posts, one pair back sway braces, one pair side sway braces and 5-8 shelves. Starter/Adder units 10'-3" include two pairs back sway braces



725
DARK GRAY (HG)

HI-TECH CLOSED SHELVING UNITS



W	D	H		5-Shelf Unit Cat No.	6-Shelf Unit Cat No.	8-Shelf Unit Cat No.	Shelf Capacity*
Medium-Duty							
36	12	87	Starter	4520-12	4521-12	4523-12	500*
36	12	87	Adder	A4520-12	A4521-12	A4523-12	500*
36	18	87	Starter	4520-18	4521-18	4523-18	500*
36	18	87	Adder	A4520-18	A4521-18	A4523-18	500*
36	24	87	Starter	4520-24	4521-24	4523-24	500*
36	24	87	Adder	A4520-24	A4521-24	A4523-24	500*
48	12	87	Starter	4720-12	4721-12	4723-12	375*
48	12	87	Adder	A4720-12	A4721-12	A4723-12	375*
48	18	87	Starter	4720-18	4721-18	4723-18	375*
48	18	87	Adder	A4720-18	A4721-18	A4723-18	375*
48	24	87	Starter	4720-24	4721-24	4723-24	350*
48	24	87	Adder	A4720-24	A4721-24	A4723-24	350*
Heavy-Duty							
36	12	87	Starter	5520-12	5521-12	5523-12	800*
36	12	87	Adder	A5520-12	A5521-12	A5523-12	800*
36	18	87	Starter	5520-18	5521-18	5523-18	800*
36	18	87	Adder	A5520-18	A5521-18	A5523-18	800*
36	24	87	Starter	5520-24	5521-24	5523-24	800*
36	24	87	Adder	A5520-24	A5521-24	A5523-24	800*
48	12	87	Starter	5720-12	5721-12	5723-12	400*
48	12	87	Adder	A5720-12	A5721-12	A5723-12	400*
48	18	87	Starter	5720-18	5721-18	5723-18	450*
48	18	87	Adder	A5720-18	A5721-18	A5723-18	450*
48	24	87	Starter	5720-24	5721-24	5723-24	500*
48	24	87	Adder	A5720-24	A5721-24	A5723-24	500*
Extra Heavy-Duty							
36	12	87	Starter	7520-12	7521-12	7523-12	1100*
36	12	87	Adder	A7520-12	A7521-12	A7523-12	1100*
36	18	87	Starter	7520-18	7521-18	7523-18	1200*
36	18	87	Adder	A7520-18	A7521-18	A7523-18	1200*
36	24	87	Starter	7520-24	7521-24	7523-24	1250*
36	24	87	Adder	A7520-24	A7521-24	A7523-24	1250*
48	12	87	Starter	7720-12	7721-12	7723-12	750*
48	12	87	Adder	A7720-12	A7721-12	A7723-12	750*
48	18	87	Starter	7720-18	7721-18	7723-18	900*
48	18	87	Adder	A7720-18	A7721-18	A7723-18	900*
48	24	87	Starter	7720-24	7721-24	7723-24	900*
48	24	87	Adder	A7720-24	A7721-24	A7723-24	900*
Additional Shelves				Medium-Duty Cat No.	Heavy-Duty Cat No.	Extra Heavy-Duty Cat No.	
36	12			5135-3612	5138-3612	5139-3612	See Above
36	18			5135-3618	5138-3618	5139-3618	See Above
36	24			5135-3624	5138-3624	5139-3624	See Above
48	12			5135-4812	5138-4812	5139-4812	See Above
48	18			5135-4818	5138-4818	5139-4818	See Above
48	24			5135-4824	5138-4824	5139-4824	See Above



STARTER UNIT



ADDER UNIT



5 SHELF UNIT



6 SHELF UNIT



8 SHELF UNIT

HI-TECH™ STEEL SHELVING

* Shelf capacity based on a factor of 1.65

Color for all components 725 Dark Gray. Optional colors are available at a nominal charge, additional lead times apply.

Closed units: Starter units include two beaded front posts, two angle back posts, one back panel assembly, two side panel assemblies and 5-8 shelves. Adder units include one beaded front post, two angle back posts, one back panel assembly, one side panel assembly and 5-8 shelves.



725
DARK GRAY (HG)



5 SHELF
OPEN UNIT



6 SHELF
CLOSED UNIT



8 SHELF
OPEN UNIT

W	D	H		5-Shelf Unit Cat No.	6-Shelf Unit Cat No.	8-Shelf Unit Cat No.	Shelf Capacity
MEDIUM-DUTY							
36	12	87	Open	F4510-12	F4511-12	F4513-12	500*
36	12	87	Closed	F4520-12	F4521-12	F4523-12	500*
36	18	87	Open	F4510-18	F4511-18	F4513-18	500*
36	18	87	Closed	F4520-18	F4521-18	F4523-18	500*
36	24	87	Open	F4510-24	F4511-24	F4513-24	500*
36	24	87	Closed	F4520-24	F4521-24	F4523-24	500*
48	12	87	Open	F4710-12	F4711-12	F4713-12	375*
48	12	87	Closed	F4720-12	F4721-12	F4723-12	375*
48	18	87	Open	F4710-18	F4711-18	F4713-18	375*
48	18	87	Closed	F4720-18	F4721-18	F4723-18	375*
48	24	87	Open	F4710-24	F4711-24	F4713-24	350*
48	24	87	Closed	F4720-24	F4721-24	F4723-24	350*
HEAVY-DUTY							
36	12	87	Open	F5510-12	F5511-12	F5513-12	800*
36	12	87	Closed	F5520-12	F5521-12	F5523-12	800*
36	18	87	Open	F5510-18	F5511-18	F5513-18	800*
36	18	87	Closed	F5520-18	F5521-18	F5523-18	800*
36	24	87	Open	F5510-24	F5511-24	F5513-24	800*
36	24	87	Closed	F5520-24	F5521-24	F5523-24	800*
48	12	87	Open	F5710-12	F5711-12	F5713-12	400*
48	12	87	Closed	F5720-12	F5721-12	F5723-12	400*
48	18	87	Open	F5710-18	F5711-18	F5713-18	450*
48	18	87	Closed	F5720-18	F5721-18	F5723-18	450*
48	24	87	Open	F5710-24	F5711-24	F5713-24	500*
48	24	87	Closed	F5720-24	F5721-24	F5723-24	500*
EXTRA HEAVY-DUTY							
36	12	87	Open	F7510-12	F7511-12	F7513-12	1100*
36	12	87	Closed	F7520-12	F7521-12	F7523-12	1100*
36	18	87	Open	F7510-18	F7511-18	F7513-18	1200*
36	18	87	Closed	F7520-18	F7521-18	F7523-18	1200*
36	24	87	Open	F7510-24	F7511-24	F7513-24	1250*
36	24	87	Closed	F7520-24	F7521-24	F7523-24	1250*
48	12	87	Open	F7710-12	F7711-12	F7713-12	750*
48	12	87	Closed	F7720-12	F7721-12	F7723-12	750*
48	18	87	Open	F7710-18	F7711-18	F7713-18	900*
48	18	87	Closed	F7720-18	F7721-18	F7723-18	900*
48	24	87	Open	F7710-24	F7711-24	F7713-24	900*
48	24	87	Closed	F7720-24	F7721-24	F7723-24	900*

Additional Shelves		Medium-Duty Cat No.	Heavy-Duty Cat No.	Extra Heavy-Duty Cat No.	
36	12	5135-3612	5138-3612	5139-3612	See Above
36	18	5135-3618	5138-3618	5139-3618	See Above
36	24	5135-3624	5138-3624	5139-3624	See Above
48	12	5135-4812	5138-4812	5139-4812	See Above
48	18	5135-4818	5138-4818	5139-4818	See Above
48	24	5135-4824	5138-4824	5139-4824	See Above

* Shelf capacity based on a factor of 1.65

Color for all components 725 Dark Gray. Optional colors are available at a nominal charge, additional lead times apply.

Open units: Units include four angle posts, one pair back sway braces, two pair side sway braces and 5-8 shelves.

Closed units: Units include four angle posts, two side panel assemblies, one back panel assembly and 5-8 shelves.



HI-TECH MEDSAFE ANTIMICROBIAL SHELVING



Hallowell
Hallowell-List.com

+MEDSAFE™

**+ANTIMICROBIAL PROTECTION
FOR OVER 20 YEARS!**

OPEN UNITS

W	D	H		8-Shelf Unit Cat. No.	11-Shelf Unit Cat. No.	Shelf Capacity*
36	12	87	Starter	4513-12PL-AM	451C-12PL-AM	500
36	12	87	Adder	A4513-12PL-AM	A451C-12PL-AM	500
36	18	87	Starter	4513-18PL-AM	451C-18PL-AM	500
36	18	87	Adder	A4513-18PL-AM	A451C-18PL-AM	500
36	24	87	Starter	4513-24PL-AM	451C-24PL-AM	500
36	24	87	Adder	A4513-24PL-AM	A451C-24PL-AM	500
48	12	87	Starter	4713-12PL-AM	471C-12PL-AM	375
48	12	87	Adder	A4713-12PL-AM	A471C-12PL-AM	375
48	18	87	Starter	4713-18PL-AM	471C-18PL-AM	375
48	18	87	Adder	A4713-18PL-AM	A471C-18PL-AM	375
48	24	87	Starter	4713-24PL-AM	471C-24PL-AM	350
48	24	87	Adder	A4713-24PL-AM	A471C-24PL-AM	350

* Shelf capacity based on a uniformly distributed load and a safety factor of 1.65

Open Units:

Starter units include two beaded front posts, two angle back posts, one pair back sway braces, two pair side sway braces and 5-8 shelves. Adder units include one beaded front post, two angle back posts, one pair back sway braces, one pair side sway braces and 5-8 shelves.

8 SHELF
OPEN ADDER UNIT



11 SHELF
OPEN STARTER UNIT

CLOSED UNITS

W	D	H		8-Shelf Unit Cat. No.	11-Shelf Unit Cat. No.	Shelf Capacity*
36	12	87	Starter	4523-12PL-AM	452C-12PL-AM	500
36	12	87	Adder	A4523-12PL-AM	A452C-12PL-AM	500
36	18	87	Starter	4523-18PL-AM	452C-18PL-AM	500
36	18	87	Adder	A4523-18PL-AM	A452C-18PL-AM	500
36	24	87	Starter	4523-24PL-AM	452C-24PL-AM	500
36	24	87	Adder	A4523-24PL-AM	A452C-24PL-AM	500
48	12	87	Starter	4723-12PL-AM	472C-12PL-AM	375
48	12	87	Adder	A4723-12PL-AM	A472C-12PL-AM	375
48	18	87	Starter	4723-18PL-AM	472C-18PL-AM	375
48	18	87	Adder	A4723-18PL-AM	A472C-18PL-AM	375
48	24	87	Starter	4723-24PL-AM	472C-24PL-AM	350
48	24	87	Adder	A4723-24PL-AM	A472C-24PL-AM	350

* Shelf capacity based on a uniformly distributed load and a safety factor of 1.65

Closed Units:

Starter units include two beaded front posts, two angle back posts, one back panel assembly, two side panel assemblies and 5-8 shelves. Adder units include one beaded front post, two angle back posts, one back panel assembly, one side panel assembly and 5-8 shelves.



8 SHELF
CLOSED ADDER UNIT



11 SHELF
CLOSED STARTER UNIT







+MEDSAFE™

711
ANTIMICROBIAL
LIGHT GRAY
(PL-AM)

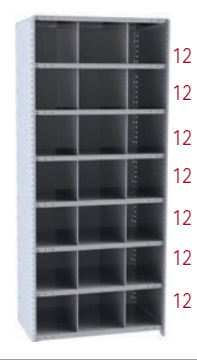
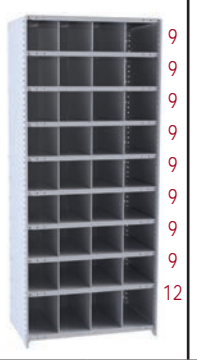
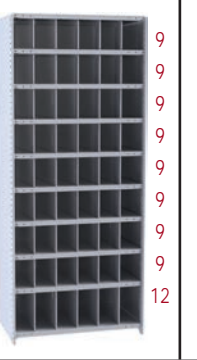
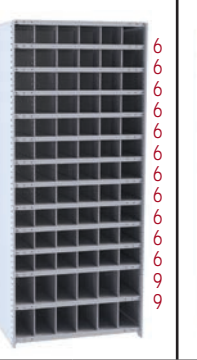
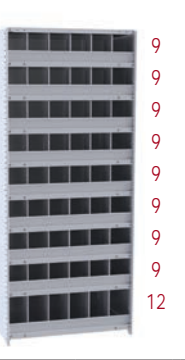
HI-TECH™ STEEL SHELVING

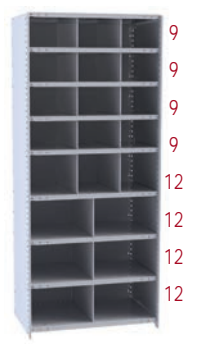
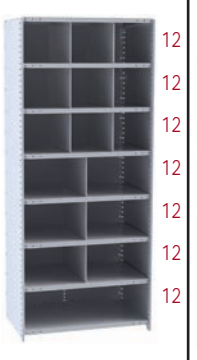
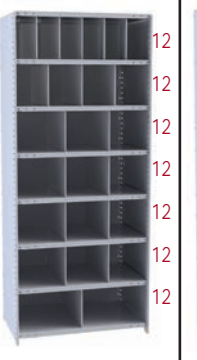
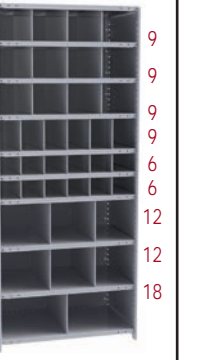
5 DAY SHIPPING ON ALL IN-STOCK PRODUCTS

					
MODEL 5525	MODEL 5526	MODEL 5527	MODEL 5528	MODEL 5529	MODEL 5530
OPENINGS	SIZE	OPENINGS	SIZE	OPENINGS	SIZE
14	18"X12"	21	12"x12"	32	9"x9" 4 9"x12"
48	6"x9" 6 6"x12"	66	6"x6" 12 6"x9"	48	6"x9" 6 6"x12"
STARTER	STARTER	STARTER	STARTER	STARTER	STARTER
12"	5525-12	5526-12	5527-12	5528-12	5529-12
18"	5525-18	5526-18	5527-18	5528-18	5529-18
24"	5525-24	5526-24	5527-24	5528-24	5529-24
ADDER	ADDER	ADDER	ADDER	ADDER	ADDER
12"	A5525-12	A5526-12	A5527-12	A5528-12	A5529-12
18"	A5525-18	A5526-18	A5527-18	A5528-18	A5529-18
24"	A5525-24	A5526-24	A5527-24	A5528-24	A5529-24
					
MODEL 5531	MODEL 5532	MODEL 5533	MODEL 5534	MODEL 5535	MODEL 5536
OPENINGS	SIZE	OPENINGS	SIZE	OPENINGS	SIZE
16	9"x9" 4 9"x12" 9 12"x12"	12	12"x9" 3 12"x12" 6 18"x12"	9	12"x12" 6 18"x12" 1 36"x12"
6	6"x12" 4 9"x12" 12 12"x12" 2 18"x12"	12	9"x9" 6 6"x9" 12 6"x6" 6 12"x12" 2 18"x12"	21	12"x12"
STARTER	STARTER	STARTER	STARTER	STARTER	STARTER
12"	5531-12	5532-12	5533-12	5534-12	5535-12
18"	5531-18	5532-18	5533-18	5534-18	5535-18
24"	5531-24	5532-24	5533-24	5534-24	5535-24
ADDER	ADDER	ADDER	ADDER	ADDER	ADDER
12"	A5531-12	A5532-12	A5533-12	A5534-12	A5535-12
18"	A5531-18	A5532-18	A5533-18	A5534-18	A5535-18
24"	A5531-24	A5532-24	A5533-24	A5534-24	A5535-24

NOTES: • Starter & adder units are made up of the same components as shown on page 23 and include metal dividers to create each specific configuration and base strips.
• All units shown are 36" wide x 87" high. 48" wide units are also available.
• Size of openings is indicated by width x height.



725
DARK GRAY
(HG)

H-POST

HEAVY-DUTY INDUSTRIAL DEEP BIN SHELVING UNITS FEATURE:

- H-Post
- Heavy-duty Hi-Tech box formed shelves
- Vertical dividers bolt in for added strength & durability
- 3/4" Plywood back painted Marine Blue [MB] to absorb impact
- Horizontal stabilizer beams prevent sway creating rigid frame.
- 18 gauge side panels
- All Units 36" wide by 87" high

Ideal for storing long items such as tubing, re-bar, florescent lights, hinges, etc.

UP TO 96" DEEP

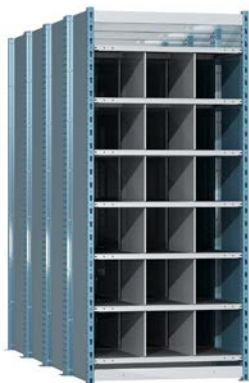

18 BIN UNIT



28 BIN UNIT

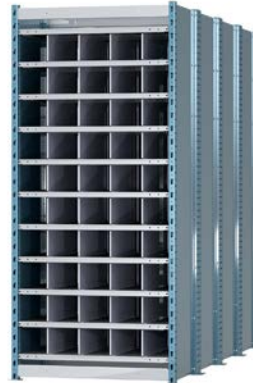

50 BIN UNIT



96 BIN UNIT

DEEP BIN SHELVING

Total # of Bins	# Bins Wide	# Bins High	Nominal Bin Dimensions			Starter Catalog No.	Adder Catalog No.
			W	D	H		
18	3	6	12	48	10-1/2	HDB18-48	AHDB18-48
18	3	6	12	72	10-1/2	HDB18-72	AHDB18-72
18	3	6	12	96	10-1/2	HDB18-96	AHDB18-96
28	4	7	9	48	9	HDB28-48	AHDB28-48
28	4	7	9	72	9	HDB28-72	AHDB28-72
28	4	7	9	96	9	HDB28-96	AHDB28-96
50	5	10	7	48	6	HDB50-48	AHDB50-48
50	5	10	7	72	6	HDB50-72	AHDB50-72
50	5	10	7	96	6	HDB50-96	AHDB50-96
96	8	12	4-1/2	48	4-1/2	HDB96-48	AHDB96-48
96	8	12	4-1/2	72	4-1/2	HDB96-72	AHDB96-72
96	8	12	4-1/2	96	4-1/2	HDB96-96	AHDB96-96

- Notes:
- Sides are H-Post with nut/bolt side panel assembly.
 - Stock Colors - Marine Blue [MB] sides with Light Gray [PL] shelves and dividers.



707 MARINE BLUE (MB)
711 LIGHT GRAY (PL)

H-POST

HALLOWELL® High Capacity Shelving

PROVIDES TWICE THE CAPACITY OF STANDARD POST SHELVING

H-Post High capacity Shelving is ideal when additional strength is required for any shelving installation. It is also recommended for multi-level high-rise applications.

H-Posts are fabricated from 14 gauge cold rolled steel and formed into a unique tubular design to provide more than twice the load capacity compared to standard posts.

H-POST SHELVING



ALL SHELVES
BACK SWAY BRACES
BACK PANELS

711
LIGHT GRAY (PL)

ALL POSTS
SIDE SWAY BRACES
SIDE PANELS

707
MARINE BLUE (MB)

COMBINE WITH STANDARD HI-TECH SHELVING COMPONENTS



H-POST

- Designed for high-density applications
- More than twice the capacity of standard posts
- Used at front and back
- Used with standard Hi-Tech components



BOX FORMED SHELVES

- Tubular welded box beam front and rear for maximum strength
- Exclusive triple bend side flanges for added strength
- Lapped and welded corners
- Top of shelf is punched to accept shelf dividers

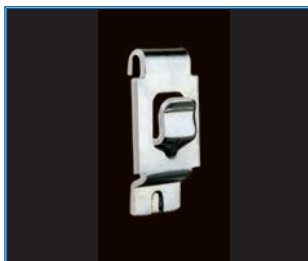

ONE PIECE SHELF CLIP

- Each shelf requires four of these sturdy and compact clips
- Clips key firmly into post slots to hold shelves securely in place
- Also fits Beaded Front, Angle Back Posts and T-Posts
- Provides independent shelf positioning on 1-1/2" centers
- Non-Intrusive clip sits flush with inside edge of front posts



BACK AND SIDE SWAY BRACES

- Standard for open units only
- 11 gauge back and side sway braces create a rigid structure
- Special triple point brace clip provides a strong rigid anchor point for back sway braces



BACK AND SIDE PANELS

- Standard for closed units only
- Standard stock models include heavy 18 gauge back and side panels for a strong and durable structure
- Multiple panels are used to create full panel height



FOOT PLATES

- Standard stock units include #5025 standard duty foot plates
- Provide a strong and secure anchoring point



AVAILABLE IN 7' AND 10' HIGH UNITS

H-POST SHELVING



STARTER UNIT



ADDER UNIT



5 SHELF UNIT



6 SHELF UNIT



8 SHELF UNIT

W	D	H		5-Shelf Unit Cat No.	6-Shelf Unit Cat No.	8-Shelf Unit Cat No.	Shelf Capacity*
Heavy-Duty							
36	18	87	Starter	H5510-1807	H5511-1807	H5513-1807	800*
36	18	87	Adder	AH5510-1807	AH5511-1807	AH5513-1807	800*
36	24	87	Starter	H5510-2407	H5511-2407	H5513-2407	800*
36	24	87	Adder	AH5510-2407	AH5511-2407	AH5513-2407	800*
36	18	123	Starter	H5510-1810	H5511-1810	H5513-1810	800*
36	18	123	Adder	AH5510-1810	AH5511-1810	AH5513-1810	800*
36	24	123	Starter	H5510-2410	H5511-2410	H5513-2410	800*
36	24	123	Adder	AH5510-2410	AH5511-2410	AH5513-2410	800*
48	18	87	Starter	H5710-1807	H5711-1807	H5713-1807	450*
48	18	87	Adder	AH5710-1807	AH5711-1807	AH5713-1807	450*
48	24	87	Starter	H5710-2407	H5711-2407	H5713-2407	500*
48	24	87	Adder	AH5710-2407	AH5711-2407	AH5713-2407	500*
48	18	123	Starter	H5710-1810	H5711-1810	H5713-1810	450*
48	18	123	Adder	AH5710-1810	AH5711-1810	AH5713-1810	450*
48	24	123	Starter	H5710-2410	H5711-2410	H5713-2410	500*
48	24	123	Adder	AH5710-2410	AH5711-2410	AH5713-2410	500*
Extra Heavy-Duty Duty							
36	18	87	Starter	H7510-1807	H7511-1807	H7513-1807	1200*
36	18	87	Adder	AH7510-1807	AH7511-1807	AH7513-1807	1200*
36	24	87	Starter	H7510-2407	H7511-2407	H7513-2407	1250*
36	24	87	Adder	AH7510-2407	AH7511-2407	AH7513-2407	1250*
36	18	123	Starter	H7510-1810	H7511-1810	H7513-1810	1200*
36	18	123	Adder	AH7510-1810	AH7511-1810	AH7513-1810	1200*
36	24	123	Starter	H7510-2410	H7511-2410	H7513-2410	1250*
36	24	123	Adder	AH7510-2410	AH7511-2410	AH7513-2410	1250*
48	18	87	Starter	H7710-1807	H7711-1807	H7713-1807	900*
48	18	87	Adder	AH7710-1807	AH7711-1807	AH7713-1807	900*
48	24	87	Starter	H7710-2407	H7711-2407	H7713-2407	900*
48	24	87	Adder	AH7710-2407	AH7711-2407	AH7713-2407	900*
48	18	123	Starter	H7710-1810	H7711-1810	H7713-1810	900*
48	18	123	Adder	AH7710-1810	AH7711-1810	AH7713-1810	900*
48	24	123	Starter	H7710-2410	H7711-2410	H7713-2410	900*
48	24	123	Adder	AH7710-2410	AH7711-2410	AH7713-2410	900*
Additional Shelves				Heavy-Duty Cat No.	Extra Heavy-Duty Cat No.		
36	18			5138-3618PL	5139-3618PL	See Above	
36	24			5138-3624PL	5139-3624PL	See Above	
48	18			5138-4818PL	5139-4818PL	See Above	
48	24			5138-4824PL	5139-4824PL	See Above	

* Shelf capacity based on a factor of 1.65

Color: All posts, side sway braces, side panels are 707 Marine Blue.
All shelves, back sway braces, back panels are 711 Light Gray

OPEN UNITS: Starter units include four posts, one back sway brace assembly, two side sway brace assemblies, foot plates and 5-8 shelves.
Adder units include two posts, one back sway brace assembly, one side sway brace assembly, foot plates and 5-8 shelves.



ALL SHELVES BACK SWAY BRACES BACK PANELS	ALL POSTS SIDE SWAY BRACES SIDE PANELS
711 LIGHT GRAY (PL)	707 MARINE BLUE (MB)

H-POST CLOSED SHELVING UNITS



Hallowell
Hallowell-List.com



AVAILABLE IN 7' AND 10' HIGH UNITS



STARTER UNIT



ADDER UNIT



5 SHELF UNIT



6 SHELF UNIT



8 SHELF UNIT

H-POST SHELVING

W	D	H		5-Shelf Unit Cat No.	6-Shelf Unit Cat No.	8-Shelf Unit Cat No.	Shelf Capacity*
Heavy-Duty							
36	18	87	Starter	H5520-1807	H5521-1807	H5523-1807	800*
36	18	87	Adder	AH5520-1807	AH5521-1807	AH5523-1807	800*
36	24	87	Starter	H5520-2407	H5521-2407	H5523-2407	800*
36	24	87	Adder	AH5520-2407	AH5521-2407	AH5523-2407	800*
36	18	123	Starter	H5520-1810	H5521-1810	H5523-1810	800*
36	18	123	Adder	AH5520-1810	AH5521-1810	AH5523-1810	800*
36	24	123	Starter	H5520-2410	H5521-2410	H5523-2410	800*
36	24	123	Adder	AH5520-2410	AH5521-2410	AH5523-2410	800*
48	18	87	Starter	H5720-1807	H5721-1807	H5723-1807	450*
48	18	87	Adder	AH5720-1807	AH5721-1807	AH5723-1807	450*
48	24	87	Starter	H5720-2407	H5721-2407	H5723-2407	500*
48	24	87	Adder	AH5720-2407	AH5721-2407	AH5723-2407	500*
48	18	123	Starter	H5720-1810	H5721-1810	H5723-1810	450*
48	18	123	Adder	AH5720-1810	AH5721-1810	AH5723-1810	450*
48	24	123	Starter	H5720-2410	H5721-2410	H5723-2410	500*
48	24	123	Adder	AH5720-2410	AH5721-2410	AH5723-2410	500*
Extra Heavy-Duty Duty							
36	18	87	Starter	H7520-1807	H7521-1807	H7523-1807	1200*
36	18	87	Adder	AH7520-1807	AH7521-1807	AH7523-1807	1200*
36	24	87	Starter	H7520-2407	H7521-2407	H7523-2407	1250*
36	24	87	Adder	AH7520-2407	AH7521-2407	AH7523-2407	1250*
36	18	123	Starter	H7520-1810	H7521-1810	H7523-1810	1200*
36	18	123	Adder	AH7520-1810	AH7521-1810	AH7523-1810	1200*
36	24	123	Starter	H7520-2410	H7521-2410	H7523-2410	1250*
36	24	123	Adder	AH7520-2410	AH7521-2410	AH7523-2410	1250*
48	18	87	Starter	H7720-1807	H7721-1807	H7723-1807	900*
48	18	87	Adder	AH7720-1807	AH7721-1807	AH7723-1807	900*
48	24	87	Starter	H7720-2407	H7721-2407	H7723-2407	900*
48	24	87	Adder	AH7720-2407	AH7721-2407	AH7723-2407	900*
48	18	123	Starter	H7720-1810	H7721-1810	H7723-1810	900*
48	18	123	Adder	AH7720-1810	AH7721-1810	AH7723-1810	900*
48	24	123	Starter	H7720-2410	H7721-2410	H7723-2410	900*
48	24	123	Adder	AH7720-2410	AH7721-2410	AH7723-2410	900*

Additional Shelves			Heavy-Duty Cat No.	Extra Heavy-Duty Cat No.	
36	18		5138-3618PL	5139-3618PL	See Above
36	24		5138-3624PL	5139-3624PL	See Above
48	18		5138-4818PL	5139-4818PL	See Above
48	24		5138-4824PL	5139-4824PL	See Above

* Shelf capacity based on a factor of 1.65

Color: All posts, side sway braces, side panels are 707 Marine Blue.
All shelves, back sway braces, back panels are 711 Light Gray

CLOSED UNITS: Starter units include four posts, one back panel assembly, two side panel assemblies, foot plates and 5-8 shelves.
Adder units include two posts, one back panel assembly, one side panel assembly, foot plates and 5-8 shelves.



ALL SHELVES
BACK SWAY BRACES
BACK PANELS
711
LIGHT GRAY (PL)

ALL POSTS
SIDE SWAY BRACES
SIDE PANELS
707
MARINE BLUE (MB)

3 DAY SHIPPING ON ALL IN-STOCK H-POST SHELVING

NO CROSS BRACES

DURATECH™

PASS-THRU STEEL SHELVING

DuraTech is Hallowell's newest line of pass-thru steel shelving requiring no cross braces allowing access from all sides while providing the maximum strength, durability and stability needed to handle most industrial applications. DuraTech offers versatility and durability for today's modern facilities.

Our complete line of shelving is designed and engineered to the highest standards.

No Cross Braces **360° Access**

A MORE EFFICIENT STORAGE SYSTEM!

- Access from all 4 sides
- Top and bottom firmly attached with steel-grip nuts for superior strength
- Available in 5, 7 and 8 shelf models
- Four Angle Posts are used per section allowing units to be individually located, bolted side-by-side or bolted back-to-back.
- Each intermediate shelf uses four sturdy and compact clips
- Clips key firmly into post slots to hold shelves securely in place
- Provides independent positioning of intermediate shelves on 1-1/2" centers
- Bottom shelf is positioned to prevent debris from collecting beneath unit



**OUR UNIQUE GRIP NUT DESIGN
CREATES A VERY STRONG AND
RIGID STRUCTURE**

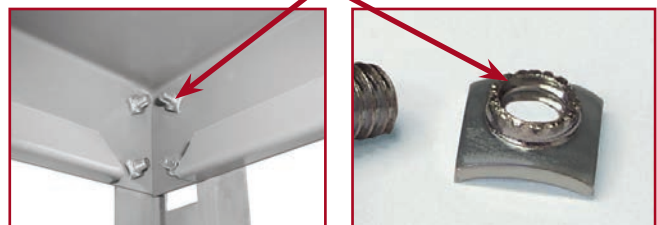

**STOCK
COLOR** 725
DARK GRAY
(HG)

DURATECH™ PASS-THRU SHELVING



Hallowell
Hallowell-List.com

DURATECH™ PASS-THRU STEEL SHELVING

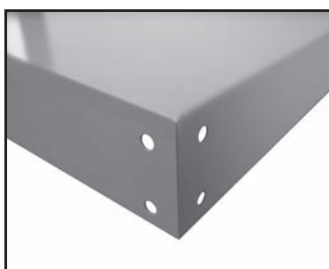

Top and bottom shelves attach with bolts at each corner providing a strong and rigid structure



Bottom shelf is positioned to prevent debris from collecting beneath unit



Top and bottom shelves are triple flanged at all four sides and bolted to angle posts at all four corners for maximum rigidity, durability and stability.



Angle posts are roll formed into a unique angle shape for maximum strength. Leg is punched on 1-1/2" centers to allow independent intermediate shelf adjustment



Intermediate shelves have a tubular flange at the front and rear, and exclusive triple bend sides for added strength.



Compression Shelf Clip for intermediate shelves

Fully Adjustable Intermediate Shelves with fixed top and bottom for a strong unit that DOES NOT require CROSS Braces



5-SHELF UNIT
3-ADJUSTABLE SHELVES



7-SHELF UNIT
5-ADJUSTABLE SHELVES



8-SHELF UNIT
6-ADJUSTABLE SHELVES

W	D	H	* Capacity Per Shelf	5-Shelf Catalog No.	7-Shelf Catalog No.	8-Shelf Catalog No.
36" WIDE UNITS						
36	12	87	800	DT5510-12	DT5512-12	DT5513-12
36	18	87	800	DT5510-18	DT5512-18	DT5513-18
36	24	87	800	DT5510-24	DT5512-24	DT5513-24
48" WIDE UNITS						
48	12	87	400	DT5710-12	DT5712-12	DT5713-12
48	18	87	450	DT5710-18	DT5712-18	DT5713-18
48	24	87	500	DT5710-24	DT5712-24	DT5713-24

All Units Include: Four angle posts, two DuraTech bolt-in shelves to be used at unit top and bottom and intermediate adjustable shelves with shelf clips applicable to unit ordered. All DuraTech shelving units are free standing and can be joined end-to-end or back-to-back.



725
DARK GRAY
(HG)

5 DAY SHIPPING ON ALL IN-STOCK PRODUCTS

BEADED FRONT POSTS



True flush construction. Slotted on 1-1/2" centers to permit easy shelf adjustment. Multiple posts can be spliced for added height.

Part No.	W	D	H	Stock Color
5002-3W	11/16"	2-9/16"	3'-3"	- - -
5002-6W	11/16"	2-9/16"	6'-3"	- - -
5002-7W	11/16"	2-9/16"	7'-3"	HG - -
5002-8W	11/16"	2-9/16"	8'-3"	- - -
5002-10W	11/16"	2-9/16"	10'-3"	HG - -
5002-12W	11/16"	2-9/16"	12'-3"	- - -

ANGLE BACK POSTS



Angles for single or end units. Slotted on 1-1/2" centers to permit easy shelf adjustment. Multiple posts can be spliced for added height.

Part No.	W	D	H	Stock Color
5004-3	1-3/16"	2-5/16"	3'-3"	- - -
5004-6	1-3/16"	2-5/16"	6'-3"	- - -
5004-7	1-3/16"	2-5/16"	7'-3"	HG - -
5004-8	1-3/16"	2-5/16"	8'-3"	- - -
5004-10	1-3/16"	2-5/16"	10'-3"	HG - -
5004-12	1-3/16"	2-5/16"	12'-3"	- - -

T-POSTS



Constructed by spot welding two back posts together. For use when adjoining models are added to form a continuous row. Multiple posts can be spliced for added height.

Part No.	W	D	H	Stock Color
5006-3	2-3/8"	2-5/16"	3'-3"	- - -
5006-6	2-3/8"	2-5/16"	6'-3"	- - -
5006-7	2-3/8"	2-5/16"	7'-3"	HG - -
5006-8	2-3/8"	2-5/16"	8'-3"	- - -
5006-10	2-3/8"	2-5/16"	10'-3"	HG - -
5006-12	2-3/8"	2-5/16"	12'-3"	- - -

POST SPLICE CHANNELS



A channel formed internal splice. Used to splice beaded front posts for added height.

Also, to splice back posts and T-posts

Part No.	W	D	H	Stock Color
5009	-	-	-	Plated

NOTE: For requirements above 16'-3" high, multiple posts can be spliced using 5009 post splice channels without compromising capacity. See page 42-43 for unit load and sway brace information.

BACK SWAY BRACES



1" x 11 ga. steel strip with safety edges. One pair of braces are bolted together at center to form an "X". Ends are rounded and pierced for mounting to rear posts. See technical data on page 42-43 for bracing information

Part No.	W	D	H	Stock Color
5342-44	36"	-	-	HG PL -
5342-55	42"/48"	-	-	HG PL -

SIDE SWAY BRACES



1" x 11 ga. steel strip with safety edges. One pair of braces are bolted together at the center to form an "X". Ends are rounded and pierced for attaching to front and rear posts in the side position. See technical data on page 42-43 for bracing information.

Part No.	W	D	H	Stock Color
5344-12	-	12"	-	HG - -
5344-15	-	15"	-	- - -
5344-18	-	18"	-	HG - -
5344-24	-	24"	-	HG - -
5344-30	-	30"	-	- - -
5344-36	-	36"	-	- - -

SHELVES

Roll formed rectangular tubular shaped front and rear edges with return flanges welded on 3" centers to underside of shelf. Sides are triple flanged. All four corners are lapped and welded. Top pierced to accept dividers.

MEDIUM-DUTY BOX BEAM SHELVES

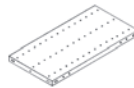

Part No.	W	D	H	CAPACITY PER SHELF	Stock Color
5135-3612	36"	12"	-	500	HG - -
5135-3618	36"	18"	-	500	HG - -
5135-3624	36"	24"	-	500	HG - -
5135-4812	48"	12"	-	375	HG - -
5135-4818	48"	18"	-	375	HG - -
5135-4824	48"	24"	-	350	HG - -

SHELF CLIP



One-piece zinc plated compression clip fits snugly against side of posts to hold shelves in place. Four required per shelf.

Part No.	W	D	H	Stock Color
5133	-	-	-	Plated

Red Part Number Denotes Stock Component
Quick-Ship Color Availability As Noted For Each Component

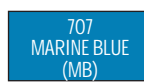
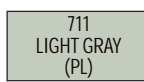

HEAVY-DUTY BOX BEAM SHELVES

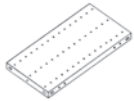

Part No.	W	D	H	CAPACITY PER SHELF	Stock Color
5138-3612	36"	12"	-	800	HG - -
5138-3615	36"	15"	-	800	- - -
5138-3618	36"	18"	-	800	HG PL -
5138-3624	36"	24"	-	800	HG PL -
5138-3630	36"	30"	-	500	- - -
5138-3636	36"	36"	-	500	- - -
5138-4212	42"	12"	-	600	- - -
5138-4215	42"	15"	-	600	- - -
5138-4218	42"	18"	-	600	- - -
5138-4224	42"	24"	-	600	- - -
5138-4230	42"	30"	-	625	- - -
5138-4232	42"	32"	-	575	- - -
5138-4236	42"	36"	-	475	- - -
5138-4812	48"	12"	-	400	HG - -
5138-4815	48"	15"	-	425	- - -
5138-4818	48"	18"	-	450	HG PL -
5138-4824	48"	24"	-	500	HG PL -
5138-4830	48"	30"	-	500	- - -
5138-4836	48"	36"	-	500	- - -

EXTRA HEAVY-DUTY BOX BEAM SHELVES

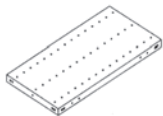

Part No.	W	D	H	CAPACITY PER SHELF	Stock Color
5139-3612	36"	12"	-	1100	HG - -
5139-3615	36"	15"	-	1100	- - -
5139-3618	36"	18"	-	1200	HG PL -
5139-3624	36"	24"	-	1250	HG PL -
5139-3630	36"	30"	-	900	- - -
5139-3636	36"	36"	-	900	- - -
5139-4212	42"	12"	-	1100	- - -
5139-4215	42"	15"	-	1100	- - -
5139-4218	42"	18"	-	1050	- - -
5139-4224	42"	24"	-	900	- - -
5139-4230	42"	30"	-	1000	- - -
5139-4232	42"	32"	-	900	- - -
5139-4236	42"	36"	-	900	- - -
5139-4812	48"	12"	-	750	HG - -
5139-4815	48"	15"	-	750	- - -
5139-4818	48"	18"	-	900	HG PL -
5139-4824	48"	24"	-	900	HG PL -
5139-4830	48"	30"	-	750	- - -
5139-4836	48"	36"	-	750	- - -

BACK PANELS 24 GAUGE

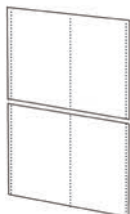

Two piece sections punched on 1" centers at vertical edges and center for mounting on back of posts and shelves in models up to 48" wide.

Part No.	W	D	H	Stock Color
5110-3603	36"	-	3'-3"	HG - -
5110-3606	36"	-	6'-3"	HG - -
5110-3607	36"	-	7'-3"	HG - -
5110-4203	42"	-	3'-3"	- - -
5110-4206	42"	-	6'-3"	- - -
5110-4207	42"	-	7'-3"	- - -
5110-4803	48"	-	3'-3"	HG - -
5110-4806	48"	-	6'-3"	HG - -
5110-4807	48"	-	7'-3"	HG - -

NOTE: Backs greater than 3'-3" will be shipped in multiple pieces.

BACK PANELS 18 GAUGE

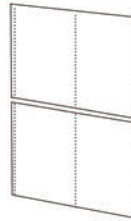

Two piece sections punched on 1" centers at vertical edges and center for mounting on back of posts and shelves in models up to 48" wide.

Part No.	W	D	H	Stock Color
5110-3603-18	36"	---	3'-3"	PL -
5110-3607-18	36"	---	7'-3"	PL -
5110-4803-18	48"	---	3'-3"	PL -
5110-4807-18	48"	---	7'-3"	PL -

NOTE: Backs greater than 3'-3" will be shipped in multiple pieces.

BACK PANEL CLIPS

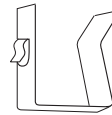

Formed to fit bottom flange of standard shelf and tabbed to pick up holes in center of back panel section. Holds back panel to shelf and prevents panel bowing.

Part No.	W	D	H	Stock Color
5120	-	-	-	Plated

BASE STRIPS

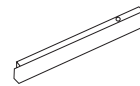

Shaped to fit directly between bottom shelf and floor. 2-15/16" high giving an overall base height including bottom shelf of 3".

Part No.	W	D	H	Stock Color
5233-36	36"	-	-	HG - -
5233-42	42"	-	-	- - -
5233-48	48"	-	-	HG - -

SIDE PANELS

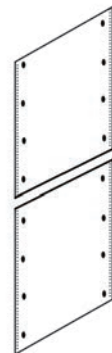

Two piece panels are bolted to standard Beaded, Angle and Tee Posts when solid sides are required.

Part No.	W	D	H	Stock Color
5093-1203	-	12"	3'-3"	HG - -
5093-1206	-	12"	6'-3"	HG - -
5093-1207	-	12"	7'-3"	HG - -
5093-1507	-	15"	7'-3"	- - -
5093-1803	-	18"	3'-3"	HG - -
5093-1806	-	18"	6'-3"	HG - -
5093-1807	-	18"	7'-3"	HG - -
5093-2403	-	24"	3'-3"	HG - -
5093-2406	-	24"	6'-3"	HG - -
5093-2407	-	24"	7'-3"	HG - -
5093-3007	-	30"	7'-3"	- - -
5093-3607	-	36"	7'-3"	- - -

Red Part Number Denotes Stock Component
Quick-Ship Color Availability As Noted For Each Component

SWINGING DOORS (WITH LOCKS)



Reinforced door / frame attaches to beaded front posts and opens quietly to a full 150°. Chrome finished handle with built-in grooved key cylinder lock. Positive 3-point locking. Universal clips (Part No. 5315) are required to mount doors on beaded front posts.

Part No.	W	D	H	Stock Color
5300-3684	36"	-	84"	HG - -

UNIVERSAL CLIP TO MOUNT DOORS



Available in sets of 6. One set required to mount swinging doors to beaded front posts.

Part No.	W	D	H	Stock Color
5315	-	-	-	Plated

WELDED END PANELS

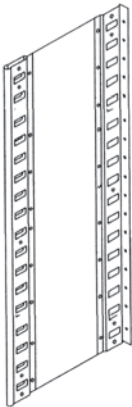

Sections consisting of beaded front post, angle back post and one-piece side panel. For individual models or starting and ending models in a continuous shelving row. Factory welded.

Part No.	W	D	H	Stock Color
5092-1203W	-	12"	3'-3"	- - -
5092-1206W	-	12"	6'-3"	- - -
5092-1207W	-	12"	7'-3"	- - -
5092-1208W	-	12"	8'-3"	- - -
5092-1210W	-	12"	10'-3"	- - -
5092-1507W	-	15"	7'-3"	- - -
5092-1803W	-	18"	3'-3"	- - -
5092-1806W	-	18"	6'-3"	- - -
5092-1807W	-	18"	7'-3"	- - -
5092-1808W	-	18"	8'-3"	- - -
5092-1810W	-	18"	10'-3"	- - -
5092-2403W	-	24"	3'-3"	- - -
5092-2406W	-	24"	6'-3"	- - -
5092-2407W	-	24"	7'-3"	- - -
5092-2408W	-	24"	8'-3"	- - -
5092-2410W	-	24"	10'-3"	- - -
5092-3007W	-	30"	7'-3"	- - -
5092-3607W	-	36"	7'-3"	- - -

LABEL HOLDERS



Pierced for attaching to front flange of shelves with top and bottom edges folded over to accommodate labels approximately 1" high.

Part No.	W	D	H	Stock Color
5370-3601	36"	-	1"	- - -
5370-4201	42"	-	1"	- - -
5370-4801	48"	-	1"	- - -

WELDED T-PANELS



Sections consisting of beaded front post, back T-Post and one-piece side panel. For use when adjoining models are added to form a continuous shelving row. Factory welded.

Part No.	W	D	H	Stock Color
5094-1203W	-	12"	3'-3"	- - -
5094-1206W	-	12"	6'-3"	- - -
5094-1207W	-	12"	7'-3"	- - -
5094-1208W	-	12"	8'-3"	- - -
5094-1210W	-	12"	10'-3"	- - -
5094-1507W	-	15"	7'-3"	- - -
5094-1803W	-	18"	3'-3"	- - -
5094-1806W	-	18"	6'-3"	- - -
5094-1807W	-	18"	7'-3"	- - -
5094-1808W	-	18"	8'-3"	- - -
5094-1810W	-	18"	10'-3"	- - -
5094-2403W	-	24"	3'-3"	- - -
5094-2406W	-	24"	6'-3"	- - -
5094-2407W	-	24"	7'-3"	- - -
5094-2408W	-	24"	8'-3"	- - -
5094-2410W	-	24"	10'-3"	- - -
5094-3007W	-	30"	7'-3"	- - -
5094-3607W	-	36"	7'-3"	- - -

BIN FRONTS



Offset type with bead at top and triple flange at bottom to telescope over shelf flange.

Part No.	W	D	H	Stock Color
5220-3601	36"	-	1"	- - -
5220-3603	36"	-	3"	- - -
5220-4203	42"	-	3"	- - -
5220-4803	48"	-	3"	- - -

PARTIAL DIVIDERS



Offset type with bead at top and triple flange at bottom to telescope over shelf flange.

Part No.	W	D	H	Stock Color
5250-1202	-	12"	2"	- - -
5250-1204	-	12"	4"	- - -
5250-1802	-	18"	2"	- - -
5250-1804	-	18"	4"	- - -

FULL DIVIDERS

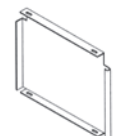

Front edge beaded. Top, bottom and rear are flanged.

Part No.	W	D	H	Stock Color
5240-1206	-	12"	6"	HG - -
5240-1209	-	12"	9"	HG - -
5240-1212	-	12"	12"	HG - -
5240-1806	-	18"	6"	HG - -
5240-1809	-	18"	9"	HG - -
5240-1812	-	18"	12"	HG - -
5240-2406	-	24"	6"	HG PL -
5240-2407.5	-	24"	7.5"	- PL -
5240-2409	-	24"	9"	HG - -
5240-2410.5	-	24"	10.5"	- PL -
5240-2412	-	24"	12"	HG PL -



725
DARK GRAY
(HG)

711
LIGHT GRAY
(PL)

707
MARINE BLUE
(MB)

Red Part Number Denotes Stock Component
Quick-Ship Color Availability As Noted For Each Component

HI-TECH & H-POST COMPONENTS



NYLON BUTTONS



Available in sets of 6. One set required to mount swinging doors to beaded front posts.

Part No.	W	D	H	Stock Color
5260	-	-	-	- - -

H-POSTS



Used for high-density shelving requirements. Used with standard Hi-Tech shelving components side sway braces (5341).

Order H-Posts front and back. Minimum order 100 posts.

Part No.	W	D	H	Stock Color
5003-7	1-1/2"	2-15/16"	7'-3"	- - MB
5003-8	1-1/2"	2-15/16"	8'-3"	- - -
5003-10	1-1/2"	2-15/16"	10'-3"	- - MB
5003-12	1-1/2"	2-15/16"	12'-3"	- - -

H-POST SPLICES

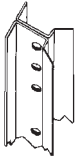

Used to splice H-posts for added height requirements

Part No.	W	D	H	Stock Color
5010	-	-	-	Plated

H-POST SIDE SWAY BRACES



Used with H-Posts only.

Part No.	W	D	H	Stock Color
5341-12	-	12"	-	- - -
5341-15	-	15"	-	- - -
5341-18	-	18"	-	- - MB
5341-24	-	24"	-	- - MB
5341-30	-	30"	-	- - -
5341-36	-	36"	-	- - -

CROSS AISLE SUPPORTS FOR BEADED POSTS

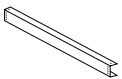

Part No.	W	D	H	Stock Color
CAS-36	40"	1-7/8"	4"	- - -
CAS-48	52"	1-7/8"	4"	- - -

CROSS AISLE SUPPORTS FOR H-POSTS



Part No.	W	D	H	Stock Color
5910-36	35 7/8"	1-7/8"	4"	- - -
5910-48	47 7/8"	1-7/8"	4"	- - -

CROSS AISLE SUPPORT BRACKETS



Part No.	W	D	H	Stock Color
5914	3 1/2"	---	3"	- - -

DOWN AISLE SUPPORTS FOR BEADED POSTS & H-POSTS

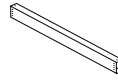

Part No.	W	D	H	Stock Color
5905-36	35 3/4"	1-7/8"	4"	- - -
5905-48	47 3/4"	1-7/8"	4"	- - -

DOWN AISLE SUPPORT BRACKETS



Part No.	W	D	H	Stock Color
5912	1 7/8"	1-7/8"	3"	- - -

COMBINATION CLIPS



Part No.	W	D	H	Stock Color
5027	---	---	---	Plated

SIDE PANELS 24 GAUGE FOR H-POST

Fabricated from 24 gauge cold rolled sheet steel, field bolted to front and back posts. Provide at all side locations for closed shelving sections. For heights greater than 3'-3", multiple sections will be provided to achieve height.

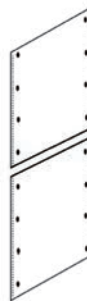

Part No.	W	D	H	Stock Color
5091-1207	---	12"	7'-3"	- - -
5091-1507	---	15"	7'-3"	- - -
5091-1803	---	18"	3'-3"	- - -
5091-1806	---	18"	6'-3"	- - -
5091-1807	---	18"	7'-3"	- - -
5091-2403	---	24"	3'-3"	- - -
5091-2406	---	24"	6'-3"	- - -
5091-2407	---	24"	7'-3"	- - -
5091-3007	---	30"	7'-3"	- - -
5091-3607	---	36"	7'-3"	- - -

SIDE PANELS 18 GAUGE FOR H-POST

Fabricated from 18 gauge cold rolled sheet steel, field bolted to front and back posts. Provide at all side locations for closed shelving sections. For heights greater than 3'-3", multiple sections will be provided to achieve height.

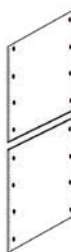

Part No.	W	D	H	Stock Color
5091-1803-18	---	18"	3'-3"	- - MB
5091-1807-18	---	18"	7'-3"	- - MB
5091-2403-18	---	24"	3'-3"	- - MB
5091-2407-18	---	24"	7'-3"	- - MB

CONNECTION STRIPS-ROW ENDS



Part No.	W	D	H	Stock Color
5114-39	2"	----	38-5/8"	- PL -
5114-42	2"	----	41-5/8"	- PL -
5114-45	2"	----	44-5/5"	- PL -
5114-51	2"	----	50-5/8"	- - -
5114-63	2"	----	62-5/8"	- - -
5114-75	2"	----	74-5/8"	- - -

Red Part Number Denotes Stock Component
Quick-Ship Color Availability As Noted For Each Component

CONNECTION STRIPS-INTERMEDIATE

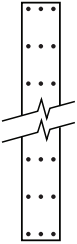

Part No.	W	D	H	Stock Color
5115-39	3"	----	38-5/8"	PL -
5115-42	3"	----	41-5/8"	PL -
5115-45	3"	----	44-5/5"	PL -
5115-51	3"	----	50-5/8"	- - -
5115-63	3"	----	62-5/8"	- - -
5115-75	3"	----	74-5/8"	- - -

H-POST FOOT PLATE-MEDIUM/LIGHT DUTY

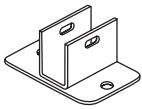

Part No.	W	D	H	Stock Color
5025	3-1/2"	2-1/4"	1/8"	Plated

FOOT PLATES FOR BEADED, ANGLE, AND T-POSTS

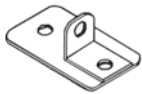

11 gauge with 14 gauge mounting bracket welded to top for bolting to post. Has 7/16" diameter. Hole for floor anchor bolts.

Part No.	W	D	H	Stock Color
5050	3-1/2"	2-1/4"	1/8"	Plated

SHIM PLATES-MEDIUM/LIGHT DUTY



Part No.	W	D	H	Stock Color
5026	3-1/2"	2-1/4"	1/16"	Plated

FOOT PLATES FOR BEADED, ANGLE, AND T-POSTS EXTRA HEAVY-DUTY



Part No.	W	D	H	Stock Color
5032	5-1/2"	2-3/8"	3/16"	Plated

SHIM PLATES FOR BEADED, ANGLE, AND T-POSTS EXTRA HEAVY-DUTY



Part No.	W	D	H	Stock Color
5033	5-1/2"	2-3/8"	1/16"	Plated

H-POST FOOT PLATE (HEAVY-DUTY)

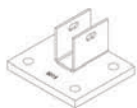

Mounting bracket welded to top for bolting inside H-Posts.

Part No.	W	D	H	Stock Color
5015	4"	3-1/2"	3/8"	Plated

H-POST SHIM PLATE



Fits under foot plate (Part no. 5015) for leveling.

Part No.	W	D	H	Stock Color
5016	4"	3-1/2"	1/16"	Plated

COMPONENT SPECIFICATIONS

Beaded Front Posts:

Fabricated from 14 gauge cold rolled steel and roll formed into an 11/16" wide x 2-9/16" deep tubular section. Rear flanges are welded on 6" centers to provide maximum strength. Sides of the post are punched 1-1/2" on center with 3/8" x 7/8" rectangular slots to receive shelf clip. Rear flanges of the post have holes punched on 3" centers for the attachment of side sway braces or field attached solid side panels. Provide (1) Beaded Front Post between each adjoining section and at row ends.

Angle Back Posts:

Fabricated of 14 gauge cold rolled steel and roll formed into a modified unequal angle shape. The long leg shall have holes punched on 1-1/2" centers with 3/8" x 7/8" rectangular slots to receive shelf clip. The leading edge shall have holes punched on 3" centers for the attachment of side sway braces. The short leg shall have holes punched on 3" centers for the attachment of back sway braces or back panels. Provide (1) Angle Back Post at each row end for open-type shelving applications.

T-Posts:

Shall be fabricated of two angle back posts. The posts are welded together back-to-back to form a "T". Welds are on 6" centers for maximum strength. Posts are used for intermediate back post applications. Provide (1) T Post between each adjoining section for open-type shelving applications.

Post Splice Channels:

(For Beaded Front Posts, Angle Posts, and T-Posts) Fabricated from 16 gauge cold rolled steel and formed into a 11/32" x 1-1/8" x 11/32" channel. 1-1/8" flange is punched with four holes for assembling to upper and lower posts. Provide at all post splices when additional height is required.

H-Posts:

Fabricated from 14 gauge cold rolled steel and roll formed into an 1-1/2" wide x 2-15/16" deep tubular section. Rear flanges are welded on 6" centers to provide maximum strength. Sides of the post are punched 1-1/2" on center with 3/8" x 7/8" rectangular slots to receive shelf clip. Rear flanges of the post have holes punched on 3" centers for the attachment of side sway braces or field attached solid side panels. Post front is slotted on 3" centers for beam connection and combination clip attachment and is punched on 3" centers for field attached back connector strips. Provide (2) H-Posts between each adjoining section and at row ends.

H-Post Splice:

Fabricated from two pieces of 16 gauge cold rolled steel formed into two special channel shapes that are spot welded together to form a 9-3/4" long connector. Splice inserts into post and include 6 holes for bolting to posts.

Side Sway Braces:

1" x 11 gauge cold rolled steel strip with safety edges to eliminate sharpness. The center of two identical pieces shall be punched to be bolted together forming an "X". Ends shall be rounded and punched for attaching to front and back posts. Provide between adjoining sections and at row ends for open-type shelving applications.

Back Sway Braces:

1" x 11 gauge cold rolled steel strip with safety edges to eliminate sharpness. The center of two identical pieces shall be punched to be bolted together forming an "X". Ends shall be rounded and punched for attaching to two back posts. Provide at back of all open-type shelving applications.

Back Panels:

Fabricated from 24 gauge cold rolled sheet steel. The two outer edges and the center shall be punched with 5/16" diameter holes on 1" centers running vertically for assembling to back posts. The center row is used to attach to rear of shelf using Back Clips. Provide at back of closed-type shelving sections. For heights greater than 3'-3", multiple sections will be provided to achieve height.



725 DARK GRAY (HG)

711 LIGHT GRAY (PL)

707 MARINE BLUE (MB)

Red Part Number Denotes Stock Component Quick-Ship Color Availability As Noted For Each Component



Side Panels:

Fabricated from 24 gauge cold rolled sheet steel, field bolted to front and back posts. Provide at all side locations for closed shelving sections. For heights greater than 3'-3", multiple sections will be provided to achieve height.

End Panels:

Fabricated from 24 gauge cold rolled sheet steel, factory bolted to a Beaded Front Post and an Angle Back Post. Provide at row ends of closed-type shelving applications or where closed ends are desired on open-type shelving applications. For heights greater than 3'-3", multiple sections will be provided to achieve height.

T-Panels:

Fabricated from 24 gauge cold rolled sheet steel factory bolted to a Beaded Front Post and two angle back Posts. Provide between sections of closed-type shelving applications. For heights greater than 3'-3", multiple sections will be provided to achieve height.

Hi-Tech Foot Plate for Beaded, Angle and T-posts #5050

3-1/2" x 2-1/4" x 12 gauge steel plate with angle bracket welded on top. The angle bracket is punched for fastening to front and back posts. The plate shall have a 7/16" diameter hole punched on one end for floor anchoring and a 3/8" diameter hole on the other end for shim plate alignment. Provide as required for floor anchoring or when shimming is required for a level installation

Hi-Tech/H-Post Foot Plate Shim Medium/Light Duty #5026

3-1/2" x 2-1/4" x 16 gauge cold rolled sheet steel. Fabricated to fit under the foot plate. One end is embossed to fit into the embossment hole in the foot plate to keep them properly aligned. The other end shall have a 7/16" diameter hole to allow floor anchoring. Provide as required when shimming is required for a level installation.

Hi-Tech Foot Plate Extra Heavy Duty #5032

5-1/2" x 2-3/8" x 7 gauge steel plate with angle bracket welded on top. The angle bracket is punched for fastening to front and back posts. The plate shall have a 7/16" diameter hole punched in both ends for floor anchoring. Provide as required for floor anchoring or when shimming is required for a level installation.

Hi-Tech Foot Plate Shim Extra Heavy Duty #5033

5-1/2" x 2-3/8" x 16 gauge cold rolled sheet steel. Fabricated to fit under the Foot Plate. One end is embossed to fit into the embossment in the Foot Plate to keep them properly aligned. The other end shall have a 7/16" diameter hole to allow floor anchoring. Provide as required when shimming is required for a level installation.

H-Post Foot Plates Medium/Light Duty #5025

3-1/2" x 2-1/4" x 11 gauge steel plate with U-bracket welded on top. The bracket is punched for fastening to H- posts. The plate shall have a 7/16" diameter hole punched on one end for floor anchoring and a 3/8" diameter hole on the other end for shim plate alignment. Provide as required for floor anchoring or when shimming is required for a level installation.

H-Post Foot Plate Heavy Duty #5015

4" x 3-1/2" x 3/8" steel plate with U-bracket welded on top. The bracket is punched for fastening to H- posts. The plate shall have 7/16" diameter holes punched for floor. Provide as required for floor anchoring or when shimming is required for a level installation.

Heavy Duty H-Post Foot Plate Shim #5016

4" x 3-1/2" x 16 gauge cold rolled sheet steel. Fabricated to fit under the foot plate. Shall have a 7/16" diameter holes to allow floor anchoring and one emboss for alignment. Provide as required when shimming is required for a level installation.

Shelves - Medium Duty:

Formed with two ribs along the horizontal front and rear edge and are stamped on the top left corner for identification. Class 0 shelves are fabricated from cold rolled steel and have roll formed rectangular tubular shaped front and rear edges with return bends resistance welded to the under side of shelf. Welds are spaced 3" on center to provide maximum strength. Sides are triple flanged to form a channel. All four corners are lapped and resistance welded to provide a rigid corner and add extra strength to the shelf. Top surface shall be punched for attaching Shelf Dividers From left to right on 1-1/2" centers, front and back, for 36" wide x 12", 15", 18" and 24" deep shelves. All other sizes are punched on 3" centers. Front and rear surfaces are punched for attaching accessories. Tubular front edge is designed to protect against impact loads. Used for uniformly distributed loads up to 500 pounds.

Shelves - Heavy Duty:

Formed with two ribs along the horizontal front and rear edge and are stamped on the top left corner for identification. Class 1 shelves are fabricated from heavy gauge cold rolled steel and have roll formed rectangular tubular shaped front and rear edges with return bends resistance welded to the under side of shelf. Welds are spaced 3" on center to provide maximum strength. Sides are triple flanged to form a channel. All four corners are lapped and resistance welded to provide a rigid corner and add extra strength to the shelf. Top surface shall be punched for attaching Shelf Dividers from left to right on 1-1/2" centers, front and back, for 36" wide x 12", 15", 18" and 24" deep shelves. All other sizes are punched on 3" centers. Front and rear surfaces are punched for attaching accessories. Tubular front edge is designed to protect against impact loads. Used for uniformly distributed loads up to 800 pounds.

Shelves - Extra Heavy Duty:

Formed with two ribs along the horizontal front and rear edge and are stamped on the top left corner for identification. Class 2 shelves are fabricated from extra heavy gauge cold rolled steel and have roll formed rectangular tubular shaped front and rear edges with return bends resistance welded to the under side of shelf. Welds are spaced 3" on center to provide maximum strength. Sides are triple flanged to form a channel. All four corners are lapped and resistance welded to provide a rigid corner and add extra strength to the shelf. Top surface shall be punched for attaching Shelf Dividers from left to right on 1-1/2" centers, front and back, for 36" wide x 12", 15", 18" and 24" deep shelves. All other sizes are punched on 3" centers. Front and rear surfaces are punched for attaching accessories. Tubular front edge is designed to protect against impact loads. Used for uniformly distributed loads up to 1,200 pounds.

Shelf Clips:

Shall be a one piece compression clip drawn from 13 gauge cold rolled steel and zinc plated. Fits snugly against side of post to hold shelves in place. Provide four per shelf.

Base Strip:

Made from 22 gauge cold rolled steel offset at top to fit behind the front flange of shelf. Punched for bolting to holes in the front flange of shelf. Bottom is flanged to resist bending.

Label Holders:

Made from 22 gauge cold rolled steel. Punched on ends and center for attaching to the front edge of shelves with top and bottom edges folded over to accommodate labels approximately 1" high.

Bin Fronts:

Fabricated from 18 gauge cold rolled steel. The top edge is formed into a bead. The bottom shall be triple flanged to telescope over shelf flange and punched to provide a means of attaching to shelf.

Full Dividers:

Fabricated from 24 gauge cold rolled steel. The front edge is beaded. Top and bottom shall be flanged and punched to provide a means of attaching to shelves. The back edge is flanged to provide rigidity. Dividers are installed using snap-in nylon fasteners.

Partial Dividers:

Fabricated from 22 gauge cold rolled steel. The top corners are rounded for increased safety. The bottom flange is punched to provide a means of attaching to shelf. Dividers are installed using snap-in nylon fasteners.

Swinging Doors:

Fabricated from 20 gauge cold rolled steel with box flanges on all four edges. Swinging doors shall be reinforced with a steel pan type panel inside the door. Doors are bolted to a welded door frame consisting of top and bottom channels and angles at the sides. The door frame side angles are punched on 1" centers for attachment. Universal Clips shall be supplied to attach door & frame assembly to the Beaded Front Posts. One chrome finished turn handle with built-in cylinder key lock shall be included providing three point positive locking.

Universal Clip:

Fabricated from 16 gauge cold rolled steel formed into an angle with three slotted holes on one flange and one long slot in the other flange, which is also offset to fit in Beaded Front Post. Provide when Swinging Doors are required.

MULTI-LEVEL HIGH-RISE SHELVING SYSTEMS

Complete high-rise modular systems make it easy to create that perfect shelving solution to maximize space in any facility.

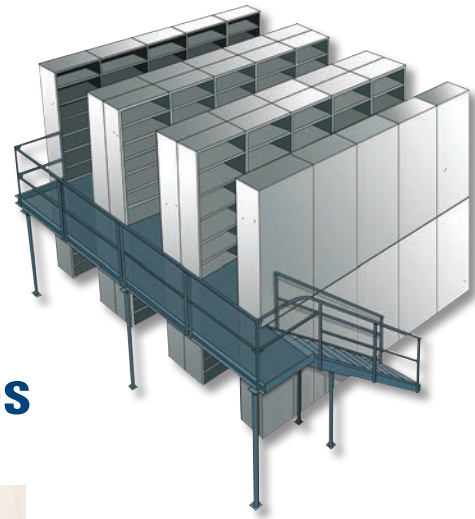

Shelving Supported Mezzanines (Deck-over shelving)



Save space by going up instead of out! Maximize your warehouse efficiency by using it's full capacity wall-to-wall and floor-to-ceiling. By using our Hi-Tech, Rivetwell, Bulk Rack and H-Post shelving Systems, we are able to double and or even triple your usable square footage instantly.

Multi-level shelving (Cat Walk System)

Using pre-engineered components, we can create a customized multi-level shelving system to meet your specific needs at a fraction of the cost of constructing a conventional mezzanine.



Multiple Products for Multiple Applications



- ✓ High Bay Storage Systems
- ✓ Shelving Supported Pick Modules
- ✓ Shelving Supported Catwalk Systems
- ✓ Safety Guard Rail Systems

Hi-Tech shelving is a complete shelving line with the strength needed to handle most industrial applications and versatility for today's modern facilities. Every shelving unit is designed and engineered to meet the highest standards.

A full complement of accessories including full dividers, partial dividers, label holders, swinging doors, post splices for multilevel systems and foot plates are available to complete your system.

Hi Tech H-Post Shelving (Floor + 2 Catwalk System)



Welded Bulk Rack (2 Level Catwalk System)



Beaded Post / Angle Post (Floor + 2 Catwalk System)

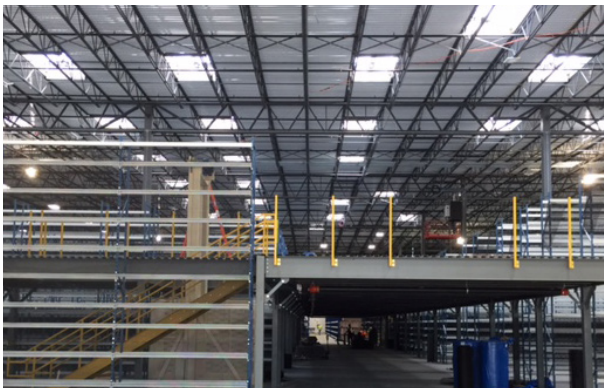

Challenge Us To Meet Your Storage Goals!

Efficient Cost Effective Designs...

Experienced Sales Engineering Surveys...

Local Sales Support Across the Country...

Stock Products in 6 Distribution Centers Nationwide

Call **866-566-0500** or Email info@Hallowell-List.com

SYSTEM LAYOUT INFORMATION

Standard Shelving with Hi-Tech Shelves

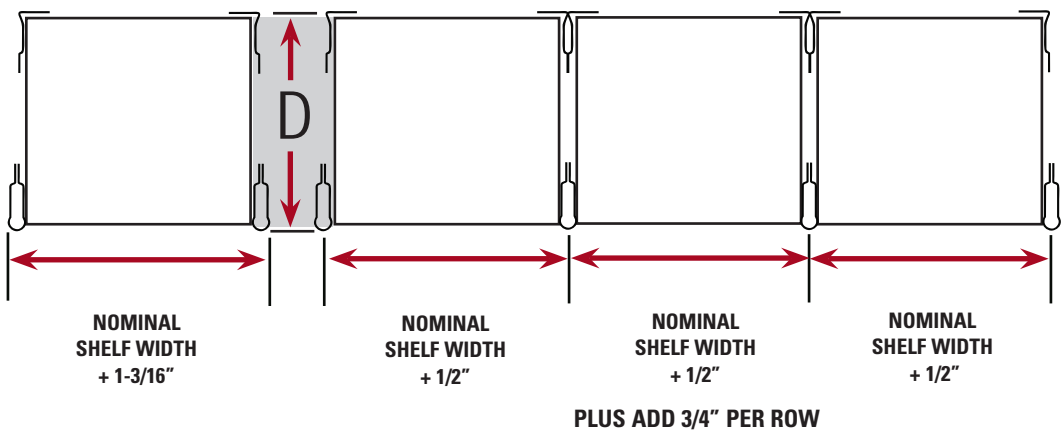

FOR "D" - SINGLE FACE ADD 3/16" TO NOMINAL SHELF DEPTH
FOR "D" - DOUBLE FACE ADD 3/8" TO NOMINAL SHELF DEPTH

H-Post Shelving with Hi-Tech Shelves

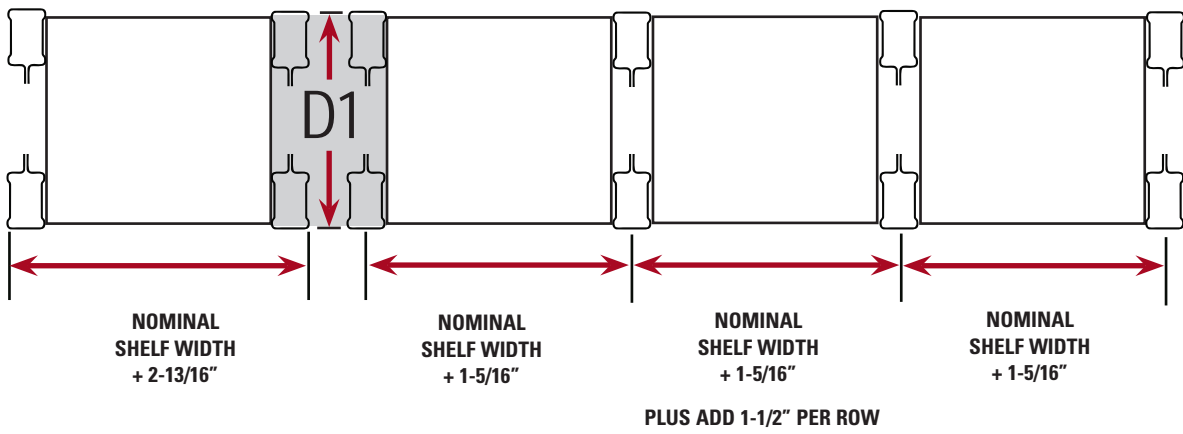

FOR "D1" - SINGLE FACE ADD 5/16" TO NOMINAL SHELF DEPTH
FOR "D1" - DOUBLE FACE CLOSED MODELS ADD 13/16" TO NOMINAL SHELF DEPTH
FOR "D1" - DOUBLE FACE OPEN MODELS ADD 29/32" TO NOMINAL SHELF DEPTH
NOTE: ACTUAL SHELF WIDTH IS 5/16" UNDER NOMINAL

NOTES:

1. Width of posts should be added to the nominal shelf width in any floor plan to determine the overall shelving width.
2. Check "D" and "D1" dimensions for depth/creepage.

UNIT LOAD CAPACITY INFORMATION - 1.92 SAFETY FACTOR

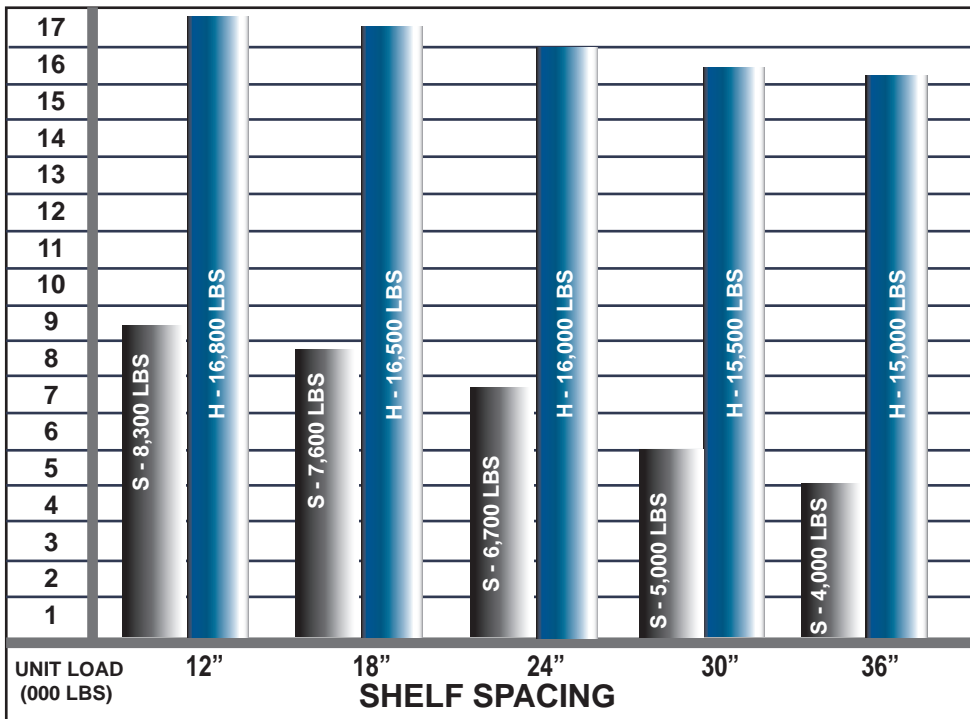

Before selecting type of post, consideration should be given to loads to be carried. Use the formula below to get unit load, then select post type from table.

$$(B-2) \times A = \text{Unit Load}$$

A = Shelf Load
(See note 2)

B = Shelves per unit
(includes top and bottom shelves)

WARNING:

- Use H-Posts for:
- High-rise applications
 - Pass-through applications regardless of load
 - High-density, multi-level applications

HI-TECH™ & H-POST SHELVING

TYPICAL SWAY BRACE INSTALLATIONS FOR SEISMIC ZONE NO. 0 & 1

Standard Shelving (Beaded Front Posts)
High-Density Shelving (H-Posts)

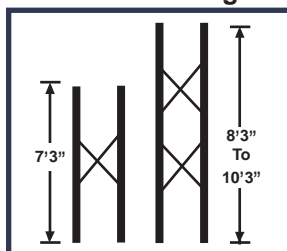

Use of Side Sway Braces
(Part No. 5344 – Standard Shelving)
(Part No. 5341–High-Density Shelving)

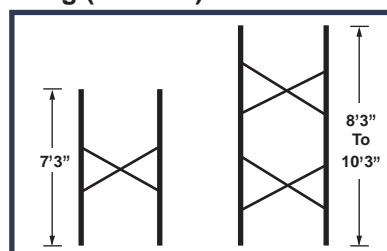

Use of Back Sway Braces (Part No. 5342) for both standard and high density shelving



- NOTES:**
- 1-When splicing posts for increased heights or for multi-level shelving, use the proper number of braces required for the height of the posts being added.
Example: a 10'-3" model increased another 10'-3" in height would require 4 sets of side sway braces and 4 sets of back braces.
 - 2-For additional bracing requirements in Seismic Zones No. 2, 3 and 4, consult the Hallowell Applications Engineering Department.



BULK RACK

H-POST BULK RACK



FEATURES:



3 shelf levels per unit adjust on 3" centers



Welded uprights consist of 14 gauge channel bracing welded to H-Post vertical members



14 gauge steel step beams with 10 gauge brackets



14 gauge front-to-back formed angle bracing supports

STOCK COLORS

BEAMS & STEEL DECKING	POSTS & UPRIGHTS
711 LIGHT GRAY (PL)	707 MARINE BLUE (MB)

Choice of optional particle board, waterfall wire and steel shelf decking



H-POST BULK RACK UNITS



W	D	*Capacity	Starter Adder	87" High Cat. No.	123" High Cat. No.
48	24	3,800	Starter	HBR482487-3S	HBR4824123-3S
48	24	3,800	Adder	HBR482487-3A	HBR4824123-3A
48	36	3,800	Starter	HBR483687-3S	HBR4836123-3S
48	36	3,800	Adder	HBR483687-3A	HBR4836123-3A
48	48	3,800	Starter	HBR484887-3S	HBR4848123-3S
48	48	3,800	Adder	HBR484887-3A	HBR4848123-3A
60	24	3,500	Starter	HBR602487-3S	HBR6024123-3S
60	24	3,500	Adder	HBR602487-3A	HBR6024123-3A
60	36	3,500	Starter	HBR603687-3S	HBR6036123-3S
60	36	3,500	Adder	HBR603687-3A	HBR6036123-3A
60	48	3,500	Starter	HBR604887-3S	HBR6048123-3S
60	48	3,500	Adder	HBR604887-3A	HBR6048123-3A
72	24	3,500	Starter	HBR722487-3S	HBR7224123-3S
72	24	3,500	Adder	HBR722487-3A	HBR7224123-3A
72	36	3,500	Starter	HBR723687-3S	HBR7236123-3S
72	36	3,500	Adder	HBR723687-3A	HBR7236123-3A
72	48	3,500	Starter	HBR724887-3S	HBR7248123-3S
72	48	3,500	Adder	HBR724887-3A	HBR7248123-3A
96	24	3,000	Starter	HBR962487-3S	HBR9624123-3S
96	24	3,000	Adder	HBR962487-3A	HBR9624123-3A
96	36	3,000	Starter	HBR963687-3S	HBR9636123-3S
96	36	3,000	Adder	HBR963687-3A	HBR9636123-3A
96	48	3,000	Starter	HBR964887-3S	HBR9648123-3S
96	48	3,000	Adder	HBR964887-3A	HBR9648123-3A
EXTRA LEVELS					
48	24	3,800	Level	HBRL4824	
48	36	3,800	Level	HBRL4836	
48	48	3,800	Level	HBRL4848	
60	24	3,500	Level	HBRL6024	
60	36	3,500	Level	HBRL6036	
60	48	3,500	Level	HBRL6048	
72	24	3,500	Level	HBRL7224	
72	36	3,500	Level	HBRL7236	
72	48	3,500	Level	HBRL7248	
96	24	3,000	Level	HBRL9624	
96	36	3,000	Level	HBRL9636	
96	48	3,000	Level	HBRL9648	

* Capacity is beam pair capacity and is based on a uniformly distributed load. Includes a 1.65 safety factor

UNIT COMPONENTS:

Starter units include 2 upright frames; add-on units include 1 upright frame.



Units with steel deck, wire deck and no deck include 1 front to back support for 48" and 60" wide and 2 for 72" and 96" wide.

Units with particle board deck include 2 front to back supports for 48" and 60" wide and 3 for 72" wide and 4 for 96" wide.



BEAMS & STEEL DECKING
711 LIGHT GRAY (PL)

POSTS & UPRIGHTS
707 MARINE BLUE (MB)

Bulk Rack Components	Catalog No.	W	D	H	Stock Color
BULK RACK WELDED UPRIGHTS					
	5031-2407	----	24"	87"	MB
	5031-3007	----	30"	87"	----
	5031-3607	----	36"	87"	MB
	5031-4207	----	42"	87"	----
	5031-4807	----	48"	87"	MB
	5031-2408	----	24"	99"	----
	5031-3008	----	30"	99"	----
	5031-3608	----	36"	99"	----
	5031-4208	----	42"	99"	----
	5031-4808	----	48"	99"	----
	5031-2410	----	24"	123"	MB
	5031-3010	----	30"	123"	----
	5031-3610	----	36"	123"	MB
	5031-4210	----	42"	123"	----
	5031-4810	----	48"	123"	MB
	5031-2412	----	24"	147"	----
	5031-3012	----	30"	147"	----
	5031-3612	----	36"	147"	----
5031-4212	----	42"	147"	----	
5031-4812	----	48"	147"	----	
BULK RACK BEAMS					
	5029-48	48"	----	3-1/2"	PL
	5029-60	60"	----	3-1/2"	PL
	5029-72	72"	----	3-1/2"	PL
	5029-84	84"	----	3-1/2"	----
	5029-96	96"	----	3-1/2"	PL
BULK RACK FRONT TO BACK SUPPORTS					
	5030-24	1"	24"	1"	PL
	5030-30	1"	30"	1"	----
	5030-36	1"	36"	1"	PL
	5030-42	1"	42"	1"	----
	5030-48	1"	48"	1"	PL

Catalog No.	W	D	*Capacity
PARTICLE BOARD DECKING			
HPB4824	48"	24"	530
HPB4830	48"	30"	440
HPB4836	48"	36"	400
HPB4842	48"	42"	300
HPB4848	48"	48"	275
HPB6024	60"	24"	615
HPB6030	60"	30"	520
HPB6036	60"	36"	380
HPB6042	60"	42"	305
HPB6048	60"	48"	230
HPB7224	72"	24"	770
HPB7230	72"	30"	680
HPB7236	72"	36"	655
HPB7242	72"	42"	670
HPB7248	72"	48"	685
HPB9624	96"	24"	1,200
HPB9630	96"	30"	1,180
HPB9636	96"	36"	1,150
HPB9642	96"	42"	1,110
HPB9648	96"	48"	960
WATERFALL WIRE DECKING			
HWDW3024	30"	24"	605
HWDW3030	30"	30"	455
HWDW3036	30"	36"	455
HWDW3042	30"	42"	300
HWDW3048	30"	48"	300
HWDW3624	36"	24"	605
HWDW3630	36"	30"	455
HWDW3636	36"	36"	455
HWDW3642	36"	42"	300
HWDW3648	36"	48"	300
HWDW4824	48"	24"	605
HWDW4830	48"	30"	455
HWDW4836	48"	36"	455
HWDW4842	48"	42"	300
HWDW4848	48"	48"	300
- For 60" wide, use 2 30" wide per level. - For 72" wide, use 2 36" wide per level. - For 96" wide, use 2 48" wide per level.			
STEEL SHELF DECKING			
HSSD4824	48"	24"	605
HSSD4830	48"	30"	455
HSSD4836	48"	36"	455
HSSD4842	48"	42"	305
HSSD4848	48"	48"	305
HSSD6024	60"	24"	1210
HSSD6030	60"	30"	910
HSSD6036	60"	36"	910
HSSD6042	60"	42"	610
HSSD6048	60"	48"	610
HSSD7224	72"	24"	1210
HSSD7230	72"	30"	910
HSSD7236	72"	36"	910
HSSD7242	72"	42"	610
HSSD7248	72"	48"	610
HSSD9624	96"	24"	1210
HSSD9630	96"	30"	910
HSSD9636	96"	36"	910
HSSD9642	96"	42"	610
HSSD9648	96"	48"	610

* Capacity is based on a uniformly distributed load and includes a 1.65 safety factor



BEAMS & STEEL DECKING	POSTS & UPRIGHTS
711 LIGHT GRAY (PL)	707 MARINE BLUE (MB)

REEL RACK

With Hallowell's H-Post as the vertical members of this unique storage rack, our Reel Storage Rack provides the strength and adjustability to store and dispense a wide variety of cable, rope and wire or any other spooled material.



99" HIGH
3-AXLE UNIT



123" HIGH
4-AXLE UNIT



HEAVY-DUTY AXLE SUPPORTS
ADJUST ON 3" CENTERS

- Axle position adjusts in 3" increments to accommodate a variety of spool diameters on the same rack
- Steel frame construction is designed to support 2,000-lbs per axle evenly distributed
- Total unit capacity of 6,000-lbs.

W	D	H	Includes	Starter Unit Cat. No.	Add-On Unit Cat. No.
REEL STORAGE RACK					
36"	36"	99"	(3) 2-3/8" O.D. Axles, 3 Pairs Axle Bracket	HRR363699-3S	HRR363699-3A
48"	36"	99"	(3) 2-3/8" O.D. Axles, 3 Pairs Axle Bracket	HRR483699-3S	HRR483699-3A
36"	36"	123"	(4) 2-3/8" O.D. Axles, 4 Pairs Axle Bracket	HRR3636123-4S	HRR3636123-4A
48"	36"	123"	(4) 2-3/8" O.D. Axles, 4 Pairs Axle Bracket	HRR4836123-4S	HRR4836123-4A



BEAMS, BASE & AXEL BRACKETS
711 LIGHT GRAY (PL)

POSTS - UPRIGHTS
707 MARINE BLUE (MB)

Starter Unit: Consists of 4 H-posts 2 base channels, 3 stabilizing beams, 2 sets of sway braces/gussets and the applicable number of axles and axle bracket pairs.

Adder Unit: Consists of 2 H-posts, 1 base channels, 3 stabilizing beams, 1 set of sway braces/gussets and the applicable number of axles and axle bracket pairs.

UTILITY BIN SHELVING

Hallowell bin shelving is a great way to organize and manage your parts department. Easily configurable with your favorite bin size, color and style. Each shelving unit is complete with (4) posts, shelves, side and back sway bracing and hardware for easy assembly.

- Shelves adjust in 1" increments
- Many shelf combinations available - see chart below
- Easy assembly
- Sway Braces for added stability
- Durable powder coat finish
- Nut & bolt assembly

FEATURES:

Angle Post (Standard-Duty):

1-1/8" x 1-5/8", 16 gauge cold rolled steel corner post uprights, 4 per unit.

Shelves:

22 gauge cold rolled steel, Triple flanged, adjust 1" on center.

Sway Braces:

1" wide 14 ga. Steel braces are bolted together at center to form an "X". Ends are rounded and pierced for mounting to rear and side posts.



**5 SHELF
39" HIGH UNIT
(BINS NOT INCLUDED)**

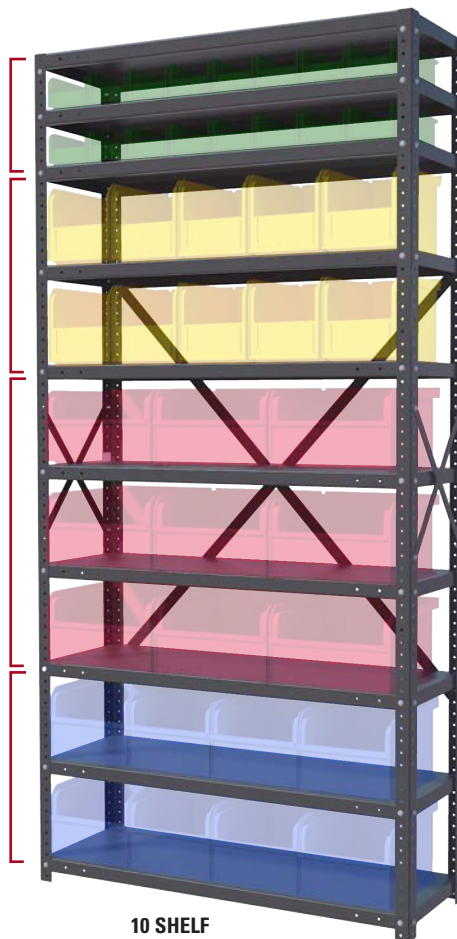

FITS 8
4" BINS
ACROSS

FITS 5
6" BINS
ACROSS

FITS 3
10" BINS
ACROSS

FITS 4
8" BINS
ACROSS

**10 SHELF
75" HIGH UNIT
(BINS NOT INCLUDED)**



1160
UTILITY GRAY (UG)



***PLASTIC BINS NOT INCLUDED**

WIDTH	DEPTH	HEIGHT	NUMBER OF SHELVES	CATALOG NO.	LOAD CAPACITY	COLOR	*RECOMMENDED BIN WIDTH				*RECOMMENDED BIN HEIGHT
							QTY. PER SHELF				RANGE
							4"	6"	8"	10"	
39 INCH HIGH UNITS											
36	12	39	4	HUBS629-4	400 lbs	UG	8	5	4	3	7"-8"
36	12	39	5	HUBS629-5	400 lbs	UG	8	5	4	3	5"-6"
36	12	39	6	HUBS629-6	400 lbs	UG	8	5	4	3	4"-5"
36	18	39	4	HUBS689-4	400 lbs	UG	8	5	4	3	7"-8"
36	18	39	5	HUBS689-5	400 lbs	UG	8	5	4	3	5"-6"
36	18	39	6	HUBS689-6	400 lbs	UG	8	5	4	3	4"-5"
75 INCH HIGH UNITS											
36	12	75	6	HUBS625-6	400 lbs	UG	8	5	4	3	10"-11"
36	12	75	7	HUBS625-7	400 lbs	UG	8	5	4	3	8"-9"
36	12	75	8	HUBS625-8	400 lbs	UG	8	5	4	3	7"-8"
36	12	75	10	HUBS625-10	400 lbs	UG	8	5	4	3	5 7/8"-6"
36	12	75	13	HUBS625-13	400 lbs	UG	8	5	4	3	3"-4"
36	18	75	6	HUBS685-6	400 lbs	UG	8	5	4	3	10"-11"
36	18	75	7	HUBS685-7	400 lbs	UG	8	5	4	3	8"-9"
36	18	75	8	HUBS685-8	400 lbs	UG	8	5	4	3	7"-8"
36	18	75	10	HUBS685-10	400 lbs	UG	8	5	4	3	5 7/8"-6"
36	18	75	13	HUBS685-13	400 lbs	UG	8	5	4	3	3"-4"

THE PERFECT TRAFFIC SOLUTION SECURITY • TRAFFIC CONTROL • PORTABILITY

- In Stock for shipment within 5 days of receipt of order
- Quick and easy installation. Install between two walls instantly without anchors to walls or floor
- Simplified, patented pressure lock system
- Floor anchors are not required but are available for special installations
- Compact, fold-up size and heavy duty swivel casters make moving and storage easy
- Plated finish
- Padlock hasp is standard
- Cylinder locks are available for additional security
- Two or more gates can be joined together for large expanse

Here's how the exclusive Superior® Pressure Lock System works:

1. Raise unit retainer channel to vertical position and secure
2. Extend gate until rubber bumpers touch both walls
3. Lower the male lock channel (with pin) until it rests on carriage channels within guides and locking bracket.
4. Lower female lock channel (with adjustment holes) until it rests within the male lock channel with pin. Pin need not engage a hole in female lock channel.
5. Raise both channels until pin engages the hole immediately to the right. Applying moderate pressure, push both channels down until they rest within guides and locking bracket. Lock in position.

Superior® Portable Gates are ideal for:

- Schools
- Shopping Malls
- Recreation Centers
- Factories
- Libraries
- Hospitals
- Office Buildings
- Financial Institutions
- Theaters
- Museums



SUPERIOR® PORTABLE GATES

**Five sizes to accommodate 3'-6" wide to 18'-0" wide conditions.
Connect multiple gates together for wider applications.**

Model	For Openings	Collapsed Size	Height	Weight (lbs)
P601-06	3'-6" to 6'-0"	19" x 30"	6'-6-1/2"	193
P601-09	6'-0" to 9'-0"	19" x 30"	6'-6-1/2"	197
P601-12	7'-0" to 12'-0"	24" x 30"	6'-6-1/2"	254
P601-15	11'-0" to 15'-0"	30" x 30"	6'-6-1/2"	311
P601-18	13'-0" to 18'-0"	30" x 30"	6'-6-1/2"	374
PG-CL	Cylinder Locks			
PG-FAA	Floor Anchors			
PG-A	Additional Anchors			



GUARDRAIL

Hallowell guardrail is designed, engineered, and manufactured to the highest industry standards, using heavy gauge steel, and a unique integrated fastening system. This integrated system incorporates the fastening hardware as part of the column design so there will be no "stripped" out connections. A properly installed and anchored guardrail system is designed to safeguard people, property and facility assets from accidents involving material handling equipment.



Steel post cap snaps on providing a durable finished installation

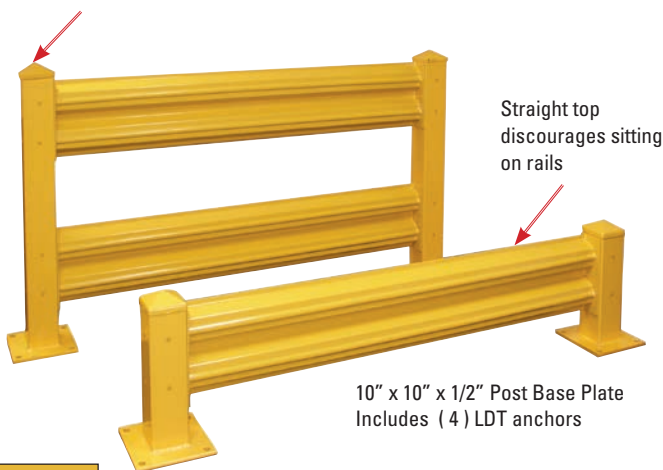

10" x 10" x 1/2" Post Base Plate
Includes (4) LDT anchors

SAFETY
YELLOW

Description	Nom. Length (Ft.)	Height (in.)	Weight (Lbs.)	Catalog Number
Rail	3'		22	GR-03
Rail	4'		26	GR-04
Rail	5'		35	GR-05
Rail	6'		41	GR-06
Rail	7'		46	GR-07
Rail	8'		53	GR-08
Rail	9'		60	GR-09
Rail	10'		65	GR-10
Post		18"	33	GRPA18-1
Post		42"	51	GRPA42-2
Lift-out rail Adapter (pair)			12	LOA
45 Degree Angle Bracket			6	45-BRACKET
*Drill Bit	-	-	0.1	17mm-Drill-Bit

* Required to install /anchor posts

Each Hallowell Guardrail system is designed for your specific safety application. It is recommended to use 18" high for impact protection of facility assets including office in-plants, conveyor systems, mezzanines, shelving and racking systems. The use of the 42" double rail system is recommended when protecting and separating pedestrians and personnel from your material handling equipment. These areas include walkways, bathrooms, entry and exit points, electrical panels, break areas, and exposed work stations.

Guardrail components have an industry approved, safety-yellow powder-coated finish. All guardrail sections are shipped with the required fasteners and other necessary hardware to properly install and anchor into your concrete floor.



Lift-out rail adapter allows for access when needed

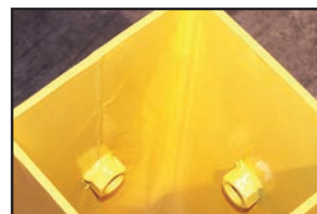

Grade 5 hex nuts are welded inside posts providing maximum bolt grip for superior installation

HALLOWELL POST PROTECTORS

Designed to protect your investment, Hallowell Post Protectors are fabricated of extra heavy-duty steel and are available in three heights to meet your specific requirements. Anchor plates are 1/4" steel that is welded to 3/8" formed steel uprights and finished in a bright safety-yellow powder coat.

AVAILABLE IN THREE HEIGHTS.

Description	Height	Catalog No.
Post Protector	12"	PP070712SY
Post Protector	18"	PP070718SY
Post Protector	24"	PP070724SY



7" x 7" x 1/4" Base Plate with the industry's widest throat increasing space between rack post and protector allowing protector to absorb impact without hitting the post

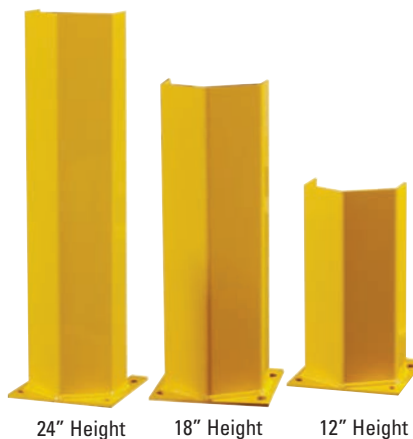

24" Height

18" Height

12" Height

Slimline SPACE SAVING CABINETS

SLIMLINE CABINETS



Features:

- All components precision engineered with no bolt heads showing on front and side panels.
- Storage - 3 adjustable full-width shelves
2 shelves in 42" high
- 2-1/2" 5-knuckle hinges
- 22-ga. Steel Construction
- Double door design, Single Door for 18" wide
- Flush mounted, recessed, squeeze latch handle
- Includes lock with 2 keys
- 16-ga. Frame
- Shelf capacity up to 150 lbs
- Shelves adjust on 2" centers
- Durable Powder-coated finish

RECESSED
SQUEEZE LATCH HANDLE



Description	Width	Depth	Height	Knock-Down Cat No.	Assembled Cat No.	Color Selection
SLIMLINE SOLID DOOR CABINETS						
Slimline, Storage	18	18	66	610S181866	610S181866A	HG,PL,ME
Slimline, Storage	24	18	66	610S241866	610S241866A	HG,PL,ME
Slimline, Storage	30	15	66	610S301566	610S301566A	HG,PL,ME

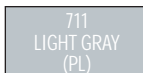

400 SERIES

COMMERCIAL KD CABINETS

2 YEAR
WARRANTY

Features:

- All components precision engineered with no bolt heads showing on front and side panels
- Body and shelves fabricated from 22 gauge steel
- Shelves easily adjust up or down in 2" increments
Triple flanged shelf front for added strength (capacity up to 200 lbs)
- Reinforced doors swing a full 180°
- Doors are factory-hung in 16 gauge frames ensuring proper performance

- 16 gauge continuous hinges
- Corner foot gussets provide added rigidity and stability (replaced by mounting plates on mobile units)
- Positive three-point locking (top, center and bottom) for secure locking
- Plated locking handle has built-in cylinder key lock (keys included)
- Mobile units include four heavy-duty locking swivel casters.

24" Deep Storage Cabinets are available in stationary and mobile versions.

Configurations:

- **Storage** (includes 4 adjustable shelves)
- **Wardrobe** (includes 1 shelf and coat rod)
- **Combination** (includes 1 full width shelf, 3 half width shelves and a half width coat rod)

Door Options:

- **Solid**
- **Safety-View** (includes polycarbonate panels in door)



BLACK



DARK GRAY
SAFETY-VIEW DOORS



TAN



708
BLACK
(ME)

725
DARK GRAY
(HG)

729
TAN
(PT)

FUNCTIONAL • DURABLE • ADAPTABLE



MOBILE STORAGE



STATIONARY WARDROBE



STATIONARY COMBINATION

400 & 405 SERIES COMMERCIAL CABINETS

Description	Width	Depth	Height	Knock-Down Cat No.	Assembled Cat No.	Colors Standard Finish
SOLID DOOR CABINETS, 400 SERIES						
Stationary, Storage	36	18	72	415S18	415S18A	ME, HG, PT
Stationary, Storage	36	24	72	415S24	415S24A	ME, HG, PT
Stationary, Storage	48	18	72	425S18	425S18A	ME, HG
Stationary, Storage	48	24	72	425S24	425S24A	ME, HG, PT
Stationary, Wardrobe	36	18	72	435W18	435W18A	ME, HG, PT
Stationary, Wardrobe	36	24	72	435W24	435W24A	ME, HG, PT
Stationary, Wardrobe	48	18	72	445W18	445W18A	ME, HG
Stationary, Wardrobe	48	24	72	445W24	445W24A	ME, HG, PT
Stationary, Combination	36	18	72	455C18	455C18A	ME, HG, PT
Stationary, Combination	36	24	72	455C24	455C24A	ME, HG, PT
Stationary, Combination	48	18	72	465C18	465C18A	ME, HG
Stationary, Combination	48	24	72	465C24	465C24A	ME, HG, PT
Mobile, Storage	36	24	72	415S24M	415S24MA	ME, HG, PT
Mobile, Storage	48	24	72	425S24M	425S24MA	ME, HG, PT
SAFETY VIEW DOOR CABINETS, 400 SERIES						
Stationary, Storage	36	18	72	415S18SV	415S18SVA	ME, HG
Stationary, Storage	36	24	72	415S24SV	415S24SVA	ME
Stationary, Wardrobe	36	18	72	435W18SV	435W18SVA	ME, HG
Stationary, Wardrobe	36	24	72	435W24SV	435W24SVA	ME
Stationary, Combination	36	18	72	455C18SV	455C18SVA	ME, HG
Stationary, Combination	36	24	72	455C24SV	455C24SVA	ME
Mobile, Storage	36	24	72	415S24SVM	415S24SVMA	ME

800 SERIES

INDUSTRIAL KD CABINETS

2 YEAR
WARRANTY

Provides maximum protection to tools, dies, delicate instruments, supplies, and personal belongings. Neat and attractive in appearance. Designed to meet government requirements.

Features:

- All components precision engineered with no bolt heads showing on front and side panels.
- 20 gauge body and 22 gauge shelves provide strength and durability.
- Shelves easily adjust up or down in 2" increments. Triple flanged shelf front for added strength (capacity up to 250 lbs).
- Reinforced doors swing a full 180°.
- Doors are factory-hung in 16 gauge frames ensuring proper performance.
- 16 gauge continuous hinges.
- Corner foot gussets provide added rigidity and stability (replaced by mounting plates on mobile units).
- Positive three-point locking (top, center and bottom) for secure locking.
- Plated locking handle has built-in cylinder key lock (keys included).
- Mobile units include four heavy-duty locking swivel casters.

Configurations:

- Storage (includes 4 adjustable shelves)
- Wardrobe (includes 1 shelf and coat rod)
- Combination (includes 1 full width shelf, 3 half width shelves and a half width coat rod)

24" Deep Storage Cabinets are available in stationary and mobile versions.



BLACK



TAN



**DARK GRAY
SAFETY-VIEW DOORS**



**LIGHT GRAY
ANTIMICROBIAL**



708
BLACK
(ME)

729
TAN
(PT)

725
DARK GRAY
(HG)

711
LIGHT GRAY
ANTIMICROBIAL
(PL-AM)

Order your cabinets in our specially formulated Light Gray Antimicrobial powder coat finish that protects against bacteria, mold & yeast for up to 20 years!

INDUSTRIAL STRENGTH STORAGE



Hallowell
Hallowell-List.com



STATIONARY STORAGE



MOBILE STORAGE



STATIONARY WARDROBE



STATIONARY COMBINATION

800 SERIES INDUSTRIAL CABINETS

+MEDSAFE™

Description	Width	Depth	Height	Knock-Down Cat No.	Assembled Cat No.	Colors Standard Finish	Light Gray Antimicrobial Finish
SOLID DOOR CABINETS, 800 SERIES							
Stationary, Storage	36	18	78	815S18	815S18A	ME, PT, HG	PL-AM
Stationary, Storage	36	24	78	815S24	815S24A	ME, PT, HG	
Stationary, Storage	48	18	78	825S18	825S18A	ME	PL-AM
Stationary, Storage	48	24	78	825S24	825S24A	ME, PT	
Stationary, Wardrobe	36	18	78	835W18	835W18A	ME, PT, HG	PL-AM
Stationary, Wardrobe	36	24	78	835W24	835W24A	ME, PT, HG	
Stationary, Wardrobe	48	18	78	845W18	845W18A	ME	PL-AM
Stationary, Wardrobe	48	24	78	845W24	845W24A	ME, PT	
Stationary, Combination	36	18	78	855C18	855C18A	ME, PT, HG	PL-AM
Stationary, Combination	36	24	78	855C24	855C24A	ME, PT, HG	
Stationary, Combination	48	18	78	865C18	865C18A	ME	PL-AM
Stationary, Combination	48	24	78	865C24	865C24A	ME, PT	
Mobile, Storage	36	24	78	815S24M	815S24MA	ME, PT, HG	PL-AM
Mobile, Storage	48	24	78	825S24M	825S24MA	ME, PT	

5 DAY SHIPPING ON ALL IN-STOCK PRODUCTS

DURATOUGH™

Classic and Galvanite™ Series All-Welded Cabinets

DURATOUGH™ ALL-WELDED CABINETS



Safety-View Door Cabinet



Ventilated Cabinet



Solid Cabinet



**STOCK
COLOR**

738
CHARCOAL
(CL)



FOR REALLY TOUGH
INDUSTRIAL APPLICATIONS



Hallowell
Hallowell-List.com

DURATOUGH™

DURATOUGH™ CABINETS

Classic Series cabinets are fabricated from prime grade cold rolled sheet steel.

Galvanite Series cabinets are fabricated from galvanized sheet steel which has a zinc-iron alloy coating that is applied at the mill providing protection against high-humidity and moist environments. This coating also prevents corrosion from spreading when the paint and/or coating is scratched away.

Heavy-Duty cabinets are fabricated from 16 gauge sheet steel and are fully-welded creating a rigid, durable unit.

Extra Heavy-Duty cabinets are fabricated from 14 gauge steel which is 25% thicker than 16 gauge providing **MAXIMUM** durability.

Safety-View® Series cabinets incorporate polycarbonate panels in both doors of our extra heavy-duty Classic Series cabinets allowing contents to be visible without compromising security.

Ventilated Series cabinets are fabricated to the same rugged standards as our extra heavy-duty Classic Series cabinets with the added benefit of being fully ventilated with diamond perforated doors and sides and a 13 gauge flattened expanded metal back.



Storage Cabinet



Combination Cabinet

DURATOUGH™ ALL-WELDED CABINETS



18-gauge full-height door stiffener provides maximum rigidity to both doors



Heavy-Duty 3/16" thick steel handle with padlock hasp.



1/8" thick latch and 3/8" diameter lock rods insure maximum security

5 DAY SHIPPING ON ALL IN-STOCK PRODUCTS

STANDARD FEATURES FOR ALL DURATOUGH™ CLASSIC AND GALVANITE™ SERIES CABINETS

- All-welded construction
- Double door design
- Solid doors are reinforced with an 18 gauge full-height door stiffener providing a rigid torque-free door.
- 3-point turn handle locking using 3/8" diameter locking rods operated by a 3/16" gauge steel handle. Handle is painted to match cabinet.
- Heavy-duty 13 gauge 7-knuckle 3-1/2" butt hinges welded to door and securely riveted to frame.
 - Solid sides are formed to be integral with vertical door frame.
 - Top is formed to be integral with horizontal top door frame.
 - Bottom is formed to be integral with horizontal bottom door frame and includes double return bends at all four sides maximizing unit rigidity.
- Back is welded to cabinet top, bottom and sides
- Shelves are formed to provide maximum capacity and are adjustable on 3" centers. Shelves bolt to shelf support channels which are welded to sides.
 - 78" high storage cabinets include 4-adjustable shelves
 - 60" high storage cabinets include 3-adjustable shelves
 - 42" high storage cabinets include 2-adjustable shelves
 - 78" high combination cabinets include one full-width upper shelf, a center partition, 3 partial-width shelves and one partial-width coat rod
- Optional leg kits are available and can be bolted on to all DuraTough cabinets.
- Color: 738 Charcoal

DURATOUGH™ CABINET LEG KITS

Catalog Number	Type	Width (In)	Depth (In)	Height (In)	Legs Per Kit
HWC4LK-1G-HG	Leg Kit	4	21	4	2
HWC4LK-4G-HG	Leg Kit	4	24	4	2

Leg kits can be added to any Hallowell DuraTough Cabinet. Legs are fabricated from galvanneal corrosion resistant steel and are easily bolted to cabinet bottom. Includes hardware for field attachment.



DURATOUGH™ CABINET DRAWERS

Catalog Number	Type	Width (In)	Depth (In)	Drawer Height
FKSCD36-2CL	2 Drawer	36	24	7.5
FKSCD48-2CL	2 Drawer	48	24	7.5
FKSCD36-3CL	3 Drawer	36	24	5
FKSCD48-3CL	3 Drawer	48	24	5

Note: Drawer units should always be installed into the lower portion of the cabinets to insure stability when opening the drawers. Only one drawer should be opened at a time.



STOCK COLOR

738 CHARCOAL (CL)

DURATOUGH™ CLASSIC & GALVANITE SERIES STEEL CABINETS



DURATOUGH™ ALL-WELDED CABINETS

DURATOUGH™ CLASSIC SERIES

Catalog Number	Type	Width (In)	Depth (In)	Height (In)	No. of Shelves
HEAVY-DUTY-16 GAUGE					
HW6SC6142-2	Storage	36	21	42	2
HW6SC6160-3	Storage	36	21	60	3
HW6SC6178-4	Storage	36	21	78	4
HW6SC6478-4	Storage	36	24	78	4
HW6SC8460-3	Storage	48	24	60	3
HW6SC8478-4	Storage	48	24	78	4
HW6SC0478-4	Storage	60	24	78	4
HW6CC6478-4	Combination	36	24	78	4
HW6CC8478-4	Combination	48	24	78	4
HW6CC0478-4	Combination	60	24	78	4
ADDITIONAL SHELVES, HEAVY-DUTY-16 GAUGE					
HW6SCS61	Shelf	36	21	---	1
HW6SCS64	Shelf	36	24	---	1
HW6SCS84	Shelf	48	24	---	1
EXTRA HEAVY-DUTY-14 GAUGE					
HW4SC6142-2	Storage	36	21	42	2
HW4SC6160-3	Storage	36	21	60	3
HW4SC6178-4	Storage	36	21	78	4
HW4SC6478-4	Storage	36	24	78	4
HW4SC8460-3	Storage	48	24	60	3
HW4SC8478-4	Storage	48	24	78	4
HW4SC0478-4	Storage	60	24	78	4
HW4CC6478-4	Combination	36	24	78	4
HW4CC8478-4	Combination	48	24	78	4
HW4CC0478-4	Combination	60	24	78	4
ADDITIONAL SHELVES, HEAVY-DUTY-14 GAUGE					
HW6SCS61	Shelf	36	21	---	1
HW6SCS64	Shelf	36	24	---	1
HW6SCS84	Shelf	48	24	---	1

DURATOUGH™ SAFETY-VIEW®

Catalog Number	Type	Width (In)	Depth (In)	Height (In)	No. of Shelves
HW4SVSC6478-4	Storage	36	24	78	4
HW4SVSC8478-4	Storage	48	24	78	4

DURATOUGH™ VENTILATED

Catalog Number	Type	Width (In)	Depth (In)	Height (In)	No. of Shelves
HW4VSC6478-4	Storage	36	24	78	4
HW4VSC8478-4	Storage	48	24	78	4

DURATOUGH™ CORROSION RESISTANT GALVANITE SERIES



DURATOUGH™ GALVANITE SERIES

Catalog Number	Type	Width (In)	Depth (In)	Height (In)	No. of Shelves
HEAVY-DUTY-16 GAUGE					
HWG6SC6142-2	Storage	36	21	42	2
HWG6SC6160-3	Storage	36	21	60	3
HWG6SC6178-4	Storage	36	21	78	4
HWG6SC6478-4	Storage	36	24	78	4
HWG6SC8460-3	Storage	48	24	60	3
HWG6SC8478-4	Storage	48	24	78	4
HWG6SC0478-4	Storage	60	24	78	4
HWG6CC6478-4	Combination	36	24	78	4
HWG6CC8478-4	Combination	48	24	78	4
HWG6CC0478-4	Combination	60	24	78	4
ADDITIONAL SHELVES, HEAVY-DUTY-16 GAUGE					
HWG6SCS61	Shelf	36	21	---	1
HWG6SCS64	Shelf	36	24	---	1
HWG6SCS84	Shelf	48	24	---	1
EXTRA HEAVY-DUTY-14 GAUGE					
HWG4SC6142-2	Storage	36	21	42	2
HWG4SC6160-3	Storage	36	21	60	3
HWG4SC6178-4	Storage	36	21	78	4
HWG4SC6478-4	Storage	36	24	78	4
HWG4SC8460-3	Storage	48	24	60	3
HWG4SC8478-4	Storage	48	24	78	4
HWG4SC0478-4	Storage	60	24	78	4
HWG4CC6478-4	Combination	36	24	78	4
HWG4CC8478-4	Combination	48	24	78	4
HWG4CC0478-4	Combination	60	24	78	4
ADDITIONAL SHELVES, HEAVY-DUTY-14 GAUGE					
HWG6SCS61	Shelf	36	21	---	1
HWG6SCS64	Shelf	36	24	---	1
HWG6SCS84	Shelf	48	24	---	1



738
CHARCOAL
(CL)

1-3/4" WORK SURFACES



Steel Top

Heavy 12 gauge steel with no holes on the work surface withstands hard shop use for years. Will not crack, splinter, gouge, or absorb oil.



Shop Top

Shop Top's layered high density particleboard offers superior screw holding characteristics. The top and bottom layers are seal to resist conventional spills. The non-conductive, splinter-proof top is 30 percent harder than maple.



Laminated Hardwood Top

Thoroughly seasoned, kiln dried hardwood, face-glued to provide an extremely durable, attractive and long lasting work surface.

Work Top Capacity:

200 lbs/sq ft evenly distributed over the entire surface.



Wire harness includes (a) duplex outlet an on/off switch with (b) wire management system and installation into leg knockouts



Caster kit include (a) swivel caster with brakes and (b) mounting plates

PRACTICAL, COMPACT AND DURABLE WORKBENCHES

Hallowell Workbenches are constructed of only the finest materials and represent the pinnacle in quality, strength, and stability. Our industrial workbenches are designed to withstand the harshest work environments year-in and year-out. With the flexible selection of standard and cost-effective components, these highly efficient units insure maximum productivity in the workplace.



Riser

Provides a 12" high x 10" deep shelf above the work surface

Drawer

24" deep x 18" wide x 6" high. Easily installs under the bench top and can be secured with an optional padlock

Back and End Stops A 3" high barrier with rounded front corners.

Lower shelf
Full width 11-3/16" deep. (150 lbs capacity)

Stringer
Required for lateral stability and acts like a stop for a second bottom shelf.

Adjustable Legs
(Allow 6" of adjustability)



708
BLACK
(ME)

Width (in.)	Depth (in.)	Height* (in.)	Top	Catalog No.	Color
Workbenches (includes legs, top and stringer)					
48	30	34	Shop Top	HWB4830E-ME	ME
60	30	34	Shop Top	HWB6030E-ME	ME
72	30	34	Shop Top	HWB7230E-ME	ME
72	36	34	Shop Top	HWB7236E-ME	ME
48	30	34	Laminated Hardwood	HWB4830M-ME	ME
60	30	34	Laminated Hardwood	HWB6030M-ME	ME
72	30	34	Laminated Hardwood	HWB7230M-ME	ME
72	36	34	Laminated Hardwood	HWB7236M-ME	ME
48	30	34	12 gauge Steel	HWB4830S-ME	ME
60	30	34	12 gauge Steel	HWB6030S-ME	ME
72	30	34	12 gauge Steel	HWB7230S-ME	ME

*Actual top height is 28-1/4" x 34-1/4" with standard legs

Width (in.)	Depth (in.)	Height (in.)	Item	Catalog No.	Color
Workbenches Add-on Accessories					
18	24	6	Drawer	HWB-BD-1824ME	ME
48	30	4-1/2	Back & End Stop Kit	HWB-BES-4830ME	ME
60	30	4-1/2	Back & End Stop Kit	HWB-BES-6030ME	ME
72	30	4-1/2	Back & End Stop Kit	HWB-BES-7230ME	ME
72	36	4-1/2	Back & End Stop Kit	HWB-BES-7236ME	ME
48	10	12	Riser	HWB-BR-48-ME	ME
60	10	12	Riser	HWB-BR-60-ME	ME
72	10	12	Riser	HWB-BR-72-ME	ME
48	14		Lower Shelf	HWB-LS-48-ME	ME
60	14		Lower Shelf	HWB-LS-60-ME	ME
72	14		Lower Shelf	HWB-LS-72-ME	ME
	24		Leg Extension	HWB-LE-24-ME	ME
-	-	-	Caster Kit 30"	HWB-CK30	ME
-	-	-	Caster Kit 36"	HWB-CK36	ME
-	-	-	Wiring Kit	HWB-WK	ME

FORT KNOX™

1 YEAR
WARRANTY

MODULAR UTILITY STORAGE AND WORKBENCH SYSTEM

THE PERFECT WORKSPACE SOLUTION



FORT KNOX MODULAR SYSTEM

By combining our adjustable Rivetwell Shelving, Heavy-Duty All-Welded Cabinets, Workbenches and Locker/Drawer units we created a uniquely functional, yet durable modular system.



Full Door
Cabinet



3 Drawer
Cabinet



6 Drawer
Cabinet



Extra Heavy-Duty
Storage Cabinet
(shown with optional drawers)

The Fort Knox Modular Utility Storage & Workbench System provides everything you need to create your own perfect workspace solution.

Fabricated from heavy gauge steel and coated with a unique textured two-tone powder coat finish, the Fort Knox system will stand up to the most demanding users.

Our intelligent design allows each major component to be utilized stand alone or in conjunction with any of the other major components.

PRE-CONFIGURED UNITS

FORT KNOX MODULAR SYSTEM



Catalog No.		Top	W (in.)	D (in.)	H (in.)	Wt. (Lbs.)
BASIC SYSTEM						
FKBASIC-SM-M	Small	Wood	60	24	78	449
FKBASIC-SM-S		Steel	60	24	78	410
FKBASIC-LG-M	Large	Wood	72	24	78	657
FKBASIC-LG-S		Steel	72	24	78	609



Catalog No.		Top	W (in.)	D (in.)	H (in.)	Wt. (Lbs.)
OPEN STORAGE SYSTEM						
FKOPENSTOR-SM-M	Small	Wood	132	24	78	711
FKOPENSTOR-SM-S		Steel	132	24	78	645
FKOPENSTOR-LG-M	Large	Wood	168	24	78	999
FKOPENSTOR-LG-S		Steel	168	24	78	909



Catalog No.		Top	W (in.)	D (in.)	H (in.)	Wt. (Lbs.)
SECURE STORAGE SYSTEM						
FKSECURESTOR-SM-M	Small	Wood	132	24	78	1386
FKSECURESTOR-SM-S		Steel	132	24	78	1347
FKSECURESTOR-LG-M	Large	Wood	168	24	78	1666
FKSECURESTOR-LG-S		Steel	168	24	78	1618



Catalog No.		Top	W (in.)	D (in.)	H (in.)	Wt. (Lbs.)
MIXED STORAGE SYSTEM						
FKMIXEDSTOR-SM-M	Small	Wood	132	24	78	975
FKMIXEDSTOR-SM-S		Steel	132	24	78	923
FKMIXEDSTOR-LG-M	Large	Wood	168	24	78	1296
FKMIXEDSTOR-LG-S		Steel	168	24	78	1227



Catalog No.		Top	W (in.)	D (in.)	H (in.)	Wt. (Lbs.)
COMPLETE SYSTEM						
FKCOMPLETE-SM-M	Small	Wood	168	24	78	1388
FKCOMPLETE-SM-S		Steel	168	24	78	1336
FKCOMPLETE-LG-M	Large	Wood	210	24	78	1770
FKCOMPLETE-LG-S		Steel	210	24	78	1701

A WORK AND STORAGE SYSTEM THAT ALLOWS YOU TO CUSTOM DESIGN YOUR OWN WORKPLACE

	Unit Width	Unit Depth	Unit Height	Catalog No.
Cabinets - Include 4 full width shelves				
	36	24	78	FKSC6478-4BR-HT
	48	24	78	FKSC8478-4BR-HT
Cabinet Drawer Kits				
2 Drawer	36	24	15	FKSCD36-2RR-HT
	48	24	15	FKSCD48-2RR-HT
3 Drawer	36	24	15	FKSCD36-3RR-HT
	48	24	15	FKSCD48-3RR-HT
Workbench pedestals				
3-Drawer	18	24	32	FKWP8432-3D-BR-HT
	24	24	32	FKWP4432-3D-BR-HT
6-Drawer	18	24	32	FKWP8432-6D-BR-HT
	24	24	32	FKWP4432-6D-BR-HT
Double Door	18	24	32	FKWP8432-1BR-HT
	24	24	32	FKWP4432-1BR-HT
Workbench tops				
Shop Top	60	24	1-3/4	FKWT6024E
	72	24	1-3/4	FKWT7224E
Laminated Hardwood	60	24	1-3/4	FKWT6024M
	72	24	1-3/4	FKWT7224M
Steel	60	24	1-3/4	FKWT6024S
	72	24	1-3/4	FKWT7224S
Lower Pedestal Shelf				
	24	8	1	FKWPS24ME-HT
	30	8	1	FKWPS24ME-HT
	36	8	1	FKWPS36ME-HT
Side & Back Rail Kits				
	60	24	4	FKSBRK6024RR-HT
	72	24	4	FKSBRK7224RR-HT

	Unit Width	Unit Depth	Unit Height	Catalog No.
Workbench Power Strips				
	48	3		FKWEP48
	60	3		FKWEP60
	72	3		FKWEP72
Light Kit				
	22	3	6	FKWLK22
Pegboard Kits Each Kit Includes (2) pcs				
	22	3/4	44-1/4	FKWBP22RR-HT
	30	3/4	44-1/4	FKWBP60RR-HT
	36	3/4	44-1/4	FKWBP72RR-HT
Pegboard Shelves				
	20	5	1	FKWS22ME-HT
	28	5	1	FKWS30ME-HT
	34	5	1	FKWBP72RR-HT
Lockers				
Single Door Lockers	18	24	78	FKL8478-1BR-HT
	24	24	78	FKL4478-1BR-HT
3-Drawers	18	24	78	FKL8478-3D-BR-HT
	24	24	78	FKL4478-3D-BR-HT
6-Drawers	18	24	78	FKL8478-6D-BR-HT
	24	24	78	FKL4478-6D-BR-HT
Shelving Units				
With Particle Board Decking	36	24	78	FKR362478-5S-W-BR-HT
	48	24	78	FKR482478-5S-W-BR-HT
With EZ-Deck Steel Decking	36	24	78	FKR362478-5S-E-BR-HT
	48	24	78	FKR482478-5S-E-BR-HT
With Featherdeck Decking	36	24	78	FKR362478-5S-F-BR-HT
	48	24	78	FKR482478-5S-F-BR-HT
Extra Shelf Level				
With Particle Board Decking	36	24	3-1/2	FKRL3624W-RR-HT
	48	24	3-1/2	FKRL4824W-RR-HT
With EZ-Deck Steel Decking	36	24	3-1/2	FKRL3624E-RR-HT
	48	24	3-1/2	FKRL4824E-RR-HT
With Featherdeck Decking	36	24	3-1/2	FKRL3624F-RR-HT
	48	24	3-1/2	FKRL4824F-RR-HT

FORT KNOX MODULAR SYSTEM

CUSTOM TEXTURED FINISH HAMMERTONE



Specially formulated with a unique hammer texture that is tough, highly durable and provides long lasting protection.

FORT KNOX SHELVING



Versatile quick assembly Rivetwell shelving provides heavy-duty storage while allowing four sided access by eliminating the need for anti-sway bracing. Four-sided beam design provides maximum decking capacity. Each unit includes 5 shelf levels including top and bottom and is available in choice of 36" and 48" wide units. Order additional levels as needed. The unique color combination of black uprights and red beams provides an attractive appearance and allows perfect integration into your custom configured system. We offer two decking choices. Order particle board or EZ-Deck steel decking for maximum capacity.

FORT KNOX SHELF OPTIONS

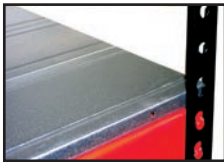

EZ-DECK

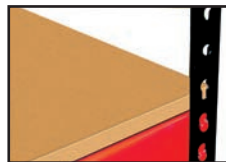

PARTICLE BOARD

If additional levels are needed for your setup, shelf levels can be ordered in each of the two available deckings to meet your specific requirements.

FORT KNOX CABINETS



**SHOWN WITH
OPTIONAL DRAWER
KIT**

Fabricated of extra heavy-duty 14 gauge steel, reinforced doors and 1,450 lb. capacity adjustable shelves, durability is an understatement. Best-in-class super-duty 13 gauge full height hinge and 3/16" ergonomically engineered cremone turn-handle insure proper door alignment and operation for a lifetime of use. Each cabinet includes 4 full-width shelves.

Doors are secured in the closed position with our high-security 3-point locking system which includes 3/8" diameter round locking rods that are held securely in place by welded-in pry-resistant retainers. These rods engage both the top and bottom of the cabinet door frame when the door is closed which the center latch rotates behind the slave door. Handle includes provisions for a padlock (locks not included).

Shelves are fully adjustable on 3" centers allowing you to maximize the cabinet's interior space. Cabinets are available in 36" and 48" widths and can accommodate our modular cabinet drawer units. With durable textured powder coat finish presented in an attractive two-tone color combining a black body with red door, you can be sure our system will be the highlight of your workspace environment.

FORT KNOX OPTIONAL DRAWER KITS



CHOOSE FROM 2 OR 3 DRAWER INSERTS

Each modular drawer unit is 15" high and is available in a 2-drawer or 3-drawer version. Drawers allow maximum weight bearing capacity by combining heavy 14 gauge construction with super-strength 500 lb. capacity full-extension glides. The full extension allows full use of each drawer.

Drawer units can be easily added to any Fort Knox and DuraTough All-Welded Cabinet allowing you to custom configure your cabinets to your specific needs.

Note: Drawer units should always be installed into the lower portion of the cabinets to insure stability when opening the drawers. Only one drawer should be opened at a time.

FORT KNOX MODULAR STORAGE SYSTEM COMPONENTS & FEATURES

FORT KNOX PEDESTAL UNITS



**3 DRAWER
PEDESTAL**



**6 DRAWER
PEDESTAL**



**DOUBLE DOOR
PEDESTAL**

Perfect as stand-alone units or as supports for workbenches. These versatile all-welded heavy-duty modules are available in multiple sizes and configurations and provide ample storage for tools.

Double Door Workbench Pedestals are perfect for storage of larger items. Our high security 3-point latching system is pad-lockable (locks not included).

Drawer Workbench Pedestals are engineered for years of smooth operation while the ergonomic handles add style. Full-extension drawer glides allow full use of drawer space. Available in both 6-drawer and 3-drawer models.

FORT KNOX WORKBENCH TOPS



WORKBENCH SHOP TOP



WORKBENCH LAMINATED HARDWOOD TOP



WORKBENCH STEEL TOP

Choose from rugged steel, laminated hardwood and composite core resin board workbench tops. Each is 1-3/4" thick and provides a perfect working surface.

FORT KNOX WORKBENCH ACCESSORIES



A - LIGHT KITS provide a convenient way to illuminate your work surface. Each light kit easily attaches to our steel pegboards allowing you to mount is where light is needed most.

B - STEEL PEGBOARD PANELS are engineered in three convenient sizes to fit perfectly into our Fort Knox System. Our unique design allows panels to be wall mounted or attached to the sides of our Fort Knox lockers and cabinets. Heavy-gauge design is perfect for industrial applications.

C - PEGBOARD SHELVES mount to the pegboard providing shelf space exactly where you need it. Available in three sizes.

D - ELECTRICAL POWER BAR provides additional power when needed. Available to match both 60" and 72" wide workbenches.

E - LOWER PEDESTAL SHELF mounts between two bench pedestals to provide out of the way storage. Available in three lengths to work with most pedestal configurations.

F - SIDE AND BACK RAIL KITS provide edging to your workbench surface to prevent items from sliding and/or rolling off. Perfect when workbenches and being used stand alone.

FORT KNOX LOCKERS/CABINETS



All-welded heavy-duty Fort Knox lockers are available in multiple sizes and configurations allowing maximum versatility. All doors include a stainless steel recessed handle with padlock hasp (locks not included).

FULL DOOR CABINET includes an upper fixed shelf with four adjustable stainless steel shelves.

COMBINATION CABINET include three stainless steel adjustable shelves with choice of 3 or 6 lower drawers. Drawers are interchangeable with our pedestal drawer units.

CUSTOM TEXTURED FINISH
HAMMERTONE

**1 YEAR
WARRANTY**

721
RELAY RED
(RR)

708
BLACK
(ME)

Specially formulated with a unique hammer texture that is tough, highly durable and provides long lasting protection.

PREMIUM ALL-PURPOSE WARDROBE LOCKERS

FEATURES:

BODY CONSTRUCTION: Knock-down, 24 gauge

BODY STYLES: Single, double and triple tier

DOOR: 16 gauge louvered for added ventilation

HINGES: Continuous piano type

HANDLE: Stainless steel recessed handle with multi-point gravity lift-type latching for a modern look and added safety. Recessed handle protects finish from being marred by padlock.

HOOKS: One double prong ceiling hook and two single hooks per single and double tier opening. One double prong ceiling hook for triple tier.

COAT ROD: Available for single tier at a nominal cost

SHELVES: Hat shelf is included in single tier lockers.

LEGS: 6" high legs are standard. Lockers without legs are available for a nominal charge.

APPEARANCE: All lockers include matching body colors. Order Finished End Panels for exposed row ends if desired. Finished End Panels install over top of universal side panels adding strength and rigidity at exposed row ends and can be ordered to match locker door/frame color.

2 YEAR WARRANTY

PIANO HINGE STANDARD

GENERAL FEATURES:

- Lockers can be ordered fully-assembled or knock-down for assembly at destination.
- Order 3-wide units for best value. Order 1-wide units to complete quantity needed for each continuous row.
- Lockers can be ordered in combination with Premium box lockers.
- All items shown are available for shipment within 5 business days of receipt of order.
- Aluminum number plates (#1-up) with mounting hardware are included. Number plate face is black with silver etched numerals. If a special numbering sequence is required, please specify when ordering. Number sequence must be consecutive numbers equal to the number of openings (doors) ordered.
- Locks are not included.

ANTIMICROBIAL PROTECTION

UPGRADED Antimicrobial Recessed Handle Finger Lift Cover

All gravity lift-type latching lockers that include recessed handles include our Antimicrobial Recessed Handle Finger Lift Cover for protection against the growth of molds and bacteria



Deep drawn stainless steel recessed handle with gravity lift-type latching for doors 20" high and higher



Single Tier,
1 wide,
1 opening
Tan



Double Tier,
1 wide,
2 openings
Marine Blue



Triple Tier,
1 wide,
3 openings
Dark Gray



NEW STOCK COLOR

Single Tier,
3 wide,
3 openings
Light Gray



NEW STOCK COLOR

Double Tier,
3 wide,
6 openings
Black

5 POPULAR FINISHES

PREMIUM QUALITY COMPETITIVELY PRICED



Width	Depth	Opening Height	Frame Height	Openings Tier	Grouping	Per Group	Knock-Down Cat No.	Fully-Assembled Cat No.	Color Selection
SINGLE TIER									
12	12	60	66	1	1-wide	1	U1226-1	U1226-1A	PT, HG
12	12	60	66	1	3-wide	3	U3226-1	U3226-1A	PT, HG
12	15	60	66	1	1-wide	1	U1256-1	U1256-1A	PT, HG
12	15	60	66	1	3-wide	3	U3256-1	U3256-1A	PT, HG
12	18	60	66	1	1-wide	1	U1286-1	U1286-1A	PT, HG
12	18	60	66	1	3-wide	3	U3286-1	U3286-1A	PT, HG
12	12	72	78	1	1-wide	1	U1228-1	U1228-1A	PT, HG, MB, ME, PL
12	12	72	78	1	3-wide	3	U3228-1	U3228-1A	PT, HG, MB, ME, PL
12	15	72	78	1	1-wide	1	U1258-1	U1258-1A	PT, HG, MB, ME, PL
12	15	72	78	1	3-wide	3	U3258-1	U3258-1A	PT, HG, MB, ME, PL
12	18	72	78	1	1-wide	1	U1288-1	U1288-1A	PT, HG, MB, ME, PL
12	18	72	78	1	3-wide	3	U3288-1	U3288-1A	PT, HG, MB, ME, PL
15	15	72	78	1	1-wide	1	U1558-1	U1558-1A	PT, HG
15	15	72	78	1	3-wide	3	U3558-1	U3558-1A	PT, HG
15	18	72	78	1	1-wide	1	U1588-1	U1588-1A	PT, HG
15	18	72	78	1	3-wide	3	U3588-1	U3588-1A	PT, HG
15	21	72	78	1	1-wide	1	U1518-1	U1518-1A	PT, HG
15	21	72	78	1	3-wide	3	U3518-1	U3518-1A	PT, HG
15	24	72	78	1	1-wide	1	U1548-1	U1548-1A	PT, HG
15	24	72	78	1	3-wide	3	U3548-1	U3548-1A	PT, HG
18	18	72	78	1	1-wide	1	U1888-1	U1888-1A	PT, HG
18	18	72	78	1	3-wide	3	U3888-1	U3888-1A	PT, HG
18	21	72	78	1	1-wide	1	U1818-1	U1818-1A	PT, HG
18	21	72	78	1	3-wide	3	U3818-1	U3818-1A	PT, HG
18	24	72	78	1	1-wide	1	U1848-1	U1848-1A	PT, HG
18	24	72	78	1	3-wide	3	U3848-1	U3848-1A	PT, HG
DOUBLE TIER									
12	12	30	66	2	1-wide	2	U1226-2	U1226-2A	PT, H
12	12	30	66	2	3-wide	6	U3226-2	U3226-2A	PT, HG
12	15	30	66	2	1-wide	2	U1256-2	U1256-2A	PT, HG
12	15	30	66	2	3-wide	6	U3256-2	U3256-2A	PT, HG
12	18	30	66	2	1-wide	2	U1286-2	U1286-2A	PT, HG
12	18	30	66	2	3-wide	6	U3286-2	U3286-2A	PT, HG
12	12	36	78	2	1-wide	2	U1228-2	U1228-2A	PT, HG, MB, ME, PL
12	12	36	78	2	3-wide	6	U3228-2	U3228-2A	PT, HG, MB, ME, PL
12	15	36	78	2	1-wide	2	U1258-2	U1258-2A	PT, HG, MB, ME, PL
12	15	36	78	2	3-wide	6	U3258-2	U3258-2A	PT, HG, MB, ME, PL
12	18	36	78	2	1-wide	2	U1288-2	U1288-2A	PT, HG, MB, ME, PL
12	18	36	78	2	3-wide	6	U3288-2	U3288-2A	PT, HG, MB, ME, PL
15	15	36	78	2	1-wide	2	U1558-2	U1558-2A	PT, HG
15	15	36	78	2	3-wide	6	U3558-2	U3558-2A	PT, HG
15	18	36	78	2	1-wide	2	U1588-2	U1588-2A	PT, HG
15	18	36	78	2	3-wide	6	U3588-2	U3588-2A	PT, HG
15	21	36	78	2	1-wide	2	U1518-2	U1518-2A	PT, HG
15	21	36	78	2	3-wide	6	U3518-2	U3518-2A	PT, HG
15	24	36	78	2	1-wide	2	U1548-2	U1548-2A	PT, HG
15	24	36	78	2	3-wide	6	U3548-2	U3548-2A	PT, HG
18	18	36	78	2	1-wide	2	U1888-2	U1888-2A	PT, HG
18	18	36	78	2	3-wide	6	U3888-2	U3888-2A	PT, HG
18	21	36	78	2	1-wide	2	U1818-2	U1588-2A	PT, HG
18	21	36	78	2	3-wide	6	U3818-2	U3818-2A	PT, HG
18	24	36	78	2	1-wide	2	U1848-2	U1848-2A	PT, HG
18	24	36	78	2	3-wide	6	U3848-2	U3848-2A	PT, HG
TRIPLE-Tier									
12	12	24	78	3	1-wide	3	U1228-3	U1228-3A	PT, HG, MB, ME, PL
12	12	24	78	3	3-wide	9	U3228-3	U3228-3A	PT, HG, MB, ME, PL
12	15	24	78	3	1-wide	3	U1258-3	U1258-3A	PT, HG, MB, ME, PL
12	15	24	78	3	3-wide	9	U3258-3	U3258-3A	PT, HG, MB, ME, PL
12	18	24	78	3	1-wide	3	U1288-3	U1288-3A	PT, HG, MB, ME, PL
12	18	24	78	3	3-wide	9	U3288-3	U3288-3A	PT, HG, MB, ME, PL

PREMIUM KD STOCK WARDROBE LOCKERS

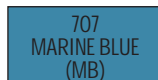

LOCKER ACCESSORIES
PAGES 86-87



Five Tier,
1 wide,
5 openings
Tan



Five Tier,
1 wide,
5 openings
Dark Gray



Six Tier,
1 wide,
6 openings
Tan



Six Tier,
1 wide,
6 openings
Dark Gray



Six Tier,
1 wide,
6 openings
Marine Blue



NEW STOCK
COLOR

Six Tier,
1 wide,
6 openings
Light Gray



NEW STOCK
COLOR

Six Tier,
1 wide,
6 openings
Black

4-Wide Wall Mount Lockers



Six Tier, 3 wide,
18 openings
Light Gray



Single-point thru-the-door friction catch door pull designed for use with a padlock or built-in lock. Shown with optional strike plate which protects door from being marred by padlock and standard piano hinge.

Sixteen-Person Lockers



HALLOWELL PREMIUM BOX LOCKERS INCLUDE LOUVERED DOORS AND ARE PERFECT FOR STORING PERSONAL ITEMS.

FEATURES:

- BODY CONSTRUCTION:** Knock-down, 24 gauge
- BODY STYLES:** Four, five, six tier, 16 Person and wall mount
- DOOR:** 18 gauge, Louvered for added ventilation
- HINGES:** Continuous piano type
- HANDLE:** Single-point projecting friction catch door pull prepared for both padlock or built-in lock. No moving parts insures quiet maintenance-free operation.
- HOOKS:** None
- COAT ROD:** None, standard on the 16 person
- SHELVES:** None
- LEGS:** 6" high legs are standard. Lockers without legs are available for a nominal charge.
- APPEARANCE:** All lockers include matching body colors. Order Finished End Panels for exposed row ends if desired. Finished End Panels install over top of universal side panels adding strength and rigidity at exposed row ends and can be ordered to match locker door/frame color.

GENERAL FEATURES:

- Lockers can be ordered fully-assembled or knock-down for assembly at destination.
- Order 3-wide units for best value. Order 1-wide units to complete quantity needed for each continuous row.
- Lockers can be ordered in combination with Premium wardrobe lockers
- All items shown are available for shipment within 5 business days of receipt of order.
- Aluminum number plates (#1-up) with mounting hardware are included. Number plate face is black with silver etched numerals. If a special numbering sequence is required, please specify when ordering. Number sequence must be consecutive numbers equal to the number of openings (doors) ordered.
- Locks are not included.



UPGRADED Antimicrobial Box Door Finger Pulls

All box door finger pulls are made of a super tough nylon material which includes an Antimicrobial agent offering protection against the growth of molds and bacteria.



Width	Depth	Opening Frame		Openings Tier	Grouping	Per Group	Knock-Down Fully-Assembled		Color Selection
		Height	Height				Cat No.	Cat No.	
FIVE TIER									
12	12	12	66	5	1-wide	5	U1226-5	U1226-5A	PT, HG
12	12	12	66	5	3-wide	15	U3226-5	U3226-5A	PT, HG
12	15	12	66	5	1-wide	5	U1256-5	U1256-5A	PT, HG
12	15	12	66	5	3-wide	15	U3256-5	U3256-5A	PT, HG
12	18	12	66	5	1-wide	5	U1286-5	U1286-5A	PT, HG
12	18	12	66	5	3-wide	15	U3286-5	U3286-5A	PT, HG
SIX TIER									
12	12	12	78	6	1-wide	6	U1228-6	U1228-6A	PT, HG, MB, ME, PL
12	12	12	78	6	3-wide	18	U3228-6	U3228-6A	PT, HG, MB, ME, PL
12	15	12	78	6	1-wide	6	U1258-6	U1258-6A	PT, HG, MB, ME, PL
12	15	12	78	6	3-wide	18	U3258-6	U3258-6A	PT, HG, MB, ME, PL
12	18	12	78	6	1-wide	6	U1288-6	U1288-6A	PT, HG, MB, ME, PL
12	18	12	78	6	3-wide	18	U3288-6	U3288-6A	PT, HG, MB, ME, PL
4-WIDE WALL MOUNT									
48	18 12	14-3/4	4-Wide Wall Mount		4		U1482-4WM	U1482-4WM-A	PT, HG
16-PERSON									
72	18	12	78	16-Person Unit		16	U1788-16	U1788-16A	PT, HG

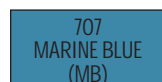
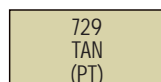

LOCKER ACCESSORIES
PAGES 86-87

READY-BUILT™ WARDROBE AND BOX LOCKERS

Ready Built™

Ready-Built Lockers Include:

READY-TO-USE!

- ✓ **Assembly**
- ✓ **Padlocks**
- ✓ **Padlock Strike Plates**



NEW STOCK COLOR

NEW STOCK COLOR



Locks Included In Stainless Steel Recessed Handles for Wardrobe Lockers



Locks and Padlock Strike Plates Included For Box Lockers

Single Tier, 1 wide, 1 openings

Double Tier, 1 wide, 2 openings

Triple Tier, 1 wide, 3 openings

Six Tier, 1 wide, 6 openings

Double Tier, 1 wide, 2 openings

STOCK COLORS

725 DARK GRAY (HG)

729 TAN (PT)

707 MARINE BLUE (MB)

NEW
708 BLACK (ME)

NEW
711 LIGHT GRAY (PL)



LOCKER ACCESSORIES PAGES 86-87

ARRIVES FULLY-ASSEMBLED READY-TO-USE



Hallowell
Hallowell-List.com

FEATURES:

BODY CONSTRUCTION: Knock-down, 24 gauge

BODY STYLES: Single, double, triple and six tier

DOOR: 16 gauge, 18 gauge for box doors

HINGES: Continuous piano type

HANDLE (wardrobe): Stainless steel recessed handle with multi-point gravity lift-type latching. Recessed handle protects finish from being marred by padlock.

HANDLE (box): Box lockers include a projecting single-point friction catch door pull. No moving parts insures quiet maintenance-free operation.

HOOKS: One double prong ceiling hook and two single hooks per single and double tier opening. One double ceiling hook for triple tier. No hooks for box lockers.

COAT RODS: Available for single tier at a nominal charge

SHELVES: Hat shelf is included in single tier lockers.

LEGS: 6" high legs are standard. Lockers without legs are available for a nominal charge.

GENERAL FEATURES:

- Available in single, double, triple and six tier models
- All lockers arrive ready-to-use. Lockers ship fully-assembled and include one combination padlock per door for true out-of-the box use.
- Padlock Strike Plates are included for six tier doors.
- Order 3-wide units for best value. Order 1-wide units to complete quantity needed for each continuous row.



UPGRADED Antimicrobial Recessed Handle Finger Lift Cover & Box Door Finger Pulls

Lift covers and finger pulls are made of a super tough nylon material which includes an Antimicrobial agent offering protection against the growth of molds and bacteria.



READY-BUILT™ WARDROBE AND BOX LOCKERS

2 YEAR WARRANTY

PIANO HINGE STANDARD

Width	Depth	Opening Height	Frame Height	Tier	Grouping	Openings Per Group	Fully-Assembled Cat No.	Color Selection
SINGLE TIER								
12	12	72	78	1	1-wide	1	URB1228-1A	PT, HG, MB, ME, PL
12	12	72	78	1	3-wide	3	URB3228-1A	PT, HG, MB, ME, PL
12	15	72	78	1	1-wide	1	URB1258-1A	PT, HG, MB, ME, PL
12	15	72	78	1	3-wide	3	URB3258-1A	PT, HG, MB, ME, PL
12	18	72	78	1	1-wide	1	URB1288-1A	PT, HG, MB, ME, PL
12	18	72	78	1	3-wide	3	URB3288-1A	PT, HG, MB, ME, PL
DOUBLE TIER								
12	12	36	78	2	1-wide	2	URB1228-2A	PT, HG, MB, ME, PL
12	12	36	78	2	3-wide	6	URB3228-2A	PT, HG, MB, ME, PL
12	15	36	78	2	1-wide	2	URB1258-2A	PT, HG, MB, ME, PL
12	15	36	78	2	3-wide	6	URB3258-2A	PT, HG, MB, ME, PL
12	18	36	78	2	1-wide	2	URB1288-2A	PT, HG, MB, ME, PL
12	18	36	78	2	3-wide	6	URB3288-2A	PT, HG, MB, ME, PL
TRIPLE TIER								
12	12	24	78	3	1-wide	3	URB1228-3A	PT, HG, MB, ME, PL
12	12	24	78	3	3-wide	9	URB3228-3A	PT, HG, MB, ME, PL
12	15	24	78	3	1-wide	3	URB1258-3A	PT, HG, MB, ME, PL
12	15	24	78	3	3-wide	9	URB3258-3A	PT, HG, MB, ME, PL
12	18	24	78	3	1-wide	3	URB1288-3A	PT, HG, MB, ME, PL
12	18	24	78	3	3-wide	9	URB3288-3A	PT, HG, MB, ME, PL
SIX TIER								
12	12	12	78	6	1-wide	6	URB1228-6A	PT, HG, MB, ME, PL
12	12	12	78	6	3-wide	18	URB3228-6A	PT, HG, MB, ME, PL
12	15	12	78	6	1-wide	6	URB1258-6A	PT, HG, MB, ME, PL
12	15	12	78	6	3-wide	18	URB3258-6A	PT, HG, MB, ME, PL
12	18	12	78	6	1-wide	6	URB1288-6A	PT, HG, MB, ME, PL
12	18	12	78	6	3-wide	18	URB3288-6A	PT, HG, MB, ME, PL

5 DAY SHIPPING ON ALL IN-STOCK PRODUCTS

Ready Built 2™

READY-TO-USE!

Ready-Built II Lockers Include:

- ✓ **Assembly**
- ✓ **Padlocks**
- ✓ **Padlock Strike Plates**
- ✓ **Slope Tops**
- ✓ **6" High Metal Bases**



Single Tier,
1 wide,
1 opening



Double Tier,
1 wide,
2 openings



Triple Tier,
1 wide,
3 openings



Double Tier,
1 wide,
2 openings



Six Tier,
1 wide,
6 openings

Slope Tops

Provide a more finished appearance and prevent items from being placed or stored on locker tops.

Padlocks

Are included for each door. 3-number combinations provide for maximum security. No need to go out and buy locks allowing immediate use of lockers upon arrival. Locks are master keyed.

Strike Plates

Aluminum plates are riveted to door to prevent padlocks from marring painted door finish on six tier lockers.

Closed Metal Base

Front and side bases close off area below lockers at 6" legs to prevent collection of debris.

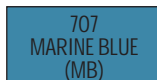

ARRIVES FULLY-ASSEMBLED READY-TO-USE



Hallowell
Hallowell-List.com

FEATURES:

BODY CONSTRUCTION: Knock-down, 24 gauge

BODY STYLES: Single, double, triple and six tier

DOOR: 16 gauge, 18 gauge for box doors, louvered for added ventilation

HINGES: Continuous piano type

HANDLE (wardrobe): Stainless steel recessed handle with multi-point gravity lift-type latching. Recessed handle protects finish from being marred by padlock.

HANDLE (box): Box lockers include a projecting single-point friction catch door pull. No moving parts insures quiet maintenance-free operation.

HOOKS: One double prong ceiling hook and two single hooks per single and double tier opening. One double ceiling hook for triple tier. No hooks for six-tier lockers

COAT RODS: Available for single tier at a nominal charge

SHELVES: Hat shelf is included in single tier lockers.

LEGS: 6" high legs are standard. Lockers without legs are available for a nominal charge

GENERAL FEATURES:

- All lockers arrive ready-to-use. Lockers ship fully-assembled and include one combination padlock per door for true out-of-the box use.
- Sloping top reduces dust accumulation and prevents item storage on locker tops.
- Closed metal bases provide a more finished appearance and eliminates the need to clean beneath lockers.
- Padlock Strike Plates are included for six tier doors.
- Order 3-wide units for best value. Order 1-wide units to complete quantity needed for each continuous row.



UPGRADED Antimicrobial Recessed Handle Finger Lift Cover & Box Door Finger Pulls

Lift covers and finger pulls are made of a super tough nylon material which includes an Antimicrobial agent offering protection against the growth of molds and bacteria.



READY-BUILT™ II WARDROBE AND BOX LOCKERS

2 YEAR WARRANTY

PIANO HINGE STANDARD

Width	Depth	Opening Height	Frame Height	Tier	Grouping	Openings Per Group	Fully-Assembled Cat No.	Color Selection
SINGLE TIER								
12	12	72	78	1	1-wide	1	URB1228-1ASB	PT, HG, MB, ME, PL
12	12	72	78	1	3-wide	3	URB3228-1ASB	PT, HG, MB, ME, PL
12	15	72	78	1	1-wide	1	URB1258-1ASB	PT, HG, MB, ME, PL
12	15	72	78	1	3-wide	3	URB3258-1ASB	PT, HG, MB, ME, PL
12	18	72	78	1	1-wide	1	URB1288-1ASB	PT, HG, MB, ME, PL
12	18	72	78	1	3-wide	3	URB3288-1ASB	PT, HG, MB, ME, PL
DOUBLE TIER								
12	12	36	78	2	1-wide	2	URB1228-2ASB	PT, HG, MB, ME, PL
12	12	36	78	2	3-wide	6	URB3228-2ASB	PT, HG, MB, ME, PL
12	15	36	78	2	1-wide	2	URB1258-2ASB	PT, HG, MB, ME, PL
12	15	36	78	2	3-wide	6	URB3258-2ASB	PT, HG, MB, ME, PL
12	18	36	78	2	1-wide	2	URB1288-2ASB	PT, HG, MB, ME, PL
12	18	36	78	2	3-wide	6	URB3288-2ASB	PT, HG, MB, ME, PL
TRIPLE TIER								
12	12	24	78	3	1-wide	3	URB1228-3ASB	PT, HG, MB, ME, PL
12	12	24	78	3	3-wide	9	URB3228-3ASB	PT, HG, MB, ME, PL
12	15	24	78	3	1-wide	3	URB1258-3ASB	PT, HG, MB, ME, PL
12	15	24	78	3	3-wide	9	URB3258-3ASB	PT, HG, MB, ME, PL
12	18	24	78	3	1-wide	3	URB1288-3ASB	PT, HG, MB, ME, PL
12	18	24	78	3	3-wide	9	URB3288-3ASB	PT, HG, MB, ME, PL
SIX TIER								
12	12	12	78	6	1-wide	6	URB1228-6ASB	PT, HG, MB, ME, PL
12	12	12	78	6	3-wide	18	URB3228-6ASB	PT, HG, MB, ME, PL
12	15	12	78	6	1-wide	6	URB1258-6ASB	PT, HG, MB, ME, PL
12	15	12	78	6	3-wide	18	URB3258-6ASB	PT, HG, MB, ME, PL
12	18	12	78	6	1-wide	6	URB1288-6ASB	PT, HG, MB, ME, PL
12	18	12	78	6	3-wide	18	URB3288-6ASB	PT, HG, MB, ME, PL



5 DAY SHIPPING ON ALL IN-STOCK PRODUCTS

+MEDSAFE™

MEDSAFE™ HEALTH CARE LOCKERS



Single Tier,
1 wide,
1 opening

Double Tier,
1 wide,
2 openings

ANTIMICROBIAL HEALTH CARE LOCKERS

Specially formulated powder coat finish protects against bacteria, mold, yeast & mildew for up to 20 years!

+ ANTIMICROBIAL PROTECTION FOR OVER 20 YEARS!

FEATURES:

BODY CONSTRUCTION: Knock-down, 24 gauge

BODY STYLES: Single and double tier

CUSTOM FEATURES: Antimicrobial finish

DOOR: 16 gauge, louvered for added ventilation,

HINGES: Continuous piano type

HANDLE: Stainless steel recessed handle with multi-point gravity lift-type latching. Recessed handle protects finish from being marred by padlock.

HOOKS: One double prong ceiling hook and two single hooks per single and double tier opening.

COAT RODS: Available for single tier at a nominal cost

SHELVES: Hat shelf is included in single tier lockers.

LEGS: All stock lockers are standard with 6" high legs. Lockers without legs are available for a nominal charge.

+ ANTIMICROBIAL PROTECTION

UPGRADED Antimicrobial Recessed Handle Finger Lift Cover

All gravity lift-type latching lockers that include recessed handles include our Antimicrobial Recessed Handle Finger Lift Cover for protection against the growth of molds and bacteria



2 YEAR WARRANTY

PIANO HINGE STANDARD



+MEDSAFE™

711
ANTIMICROBIAL
LIGHT GRAY
(PL-AM)

Width	Depth	Opening Height	Frame Height	Tier	Grouping	Openings Per Group	Knock-Down Cat No.	Fully-Assembled Cat No.	Color Selection
SINGLE TIER									
12	18	72	78	1	1-wide	1	UMS1288-1	UMS1288-1A	PL
12	18	72	78	1	3-wide	3	UMS3288-1	UMS3288-1A	PL
15	18	72	78	1	1-wide	1	UMS1588-1	UMS1588-1A	PL
15	18	72	78	1	3-wide	3	UMS3588-1	UMS3588-1A	PL
18	18	72	78	1	1-wide	1	UMS1888-1	UMS1888-1A	PL
18	18	72	78	1	3-wide	3	UMS3888-1	UMS3888-1A	PL
DOUBLE TIER									
12	18	36	78	2	1-wide	2	UMS1288-2	UMS1288-2A	PL
12	18	36	78	2	3-wide	6	UMS3288-2	UMS3288-2A	PL
15	18	36	78	2	1-wide	2	UMS1588-2	UMS1588-2A	PL
15	18	36	78	2	3-wide	6	UMS3588-2	UMS3588-2A	PL

HALLOWELL QUALITY
TO FIT A TIGHT BUDGET



Hallowell
Hallowell-List.com

\$ ValueMax™

economy lockers

ValueMax lockers offer exceptional value, quality and finish at an affordable price.

ValueMax lockers are the perfect solution for limited budget projects.

FEATURES:

BODY CONSTRUCTION: Knock-down, 24 gauge

BODY STYLES: Single, double and triple tier

DOOR: 16 gauge, louvered for added ventilation

HINGES: Continuous piano type

HANDLE: Single-point thru-the-door friction catch door pull designed for use with a padlock

HOOKS: One double prong ceiling hook and two single hooks per single and double tier opening. One double ceiling hook for triple tier.

COAT RODS: Available for single tier at a nominal cost

SHELVES: Hat shelf is included in single tier lockers.

LEGS: 6" high legs are standard. Lockers without legs are available for a nominal charge.



ANTIMICROBIAL PROTECTION
UPGRADED Antimicrobial Box Door Finger Pulls

All box door finger pulls are made of a super tough nylon material which includes an Antimicrobial agent offering protection against the growth of molds and bacteria.



2 YEAR WARRANTY

PIANO HINGE STANDARD

Width	Depth	Opening Height	Frame Height	Tier	Grouping	Openings Per Group	Knock-Down Cat No.	Fully-Assembled Cat No.	Color Selection
SINGLE TIER									
12	12	72	78	1	1-wide	1	UH1228-1	UH1228-1A	PT, HG
12	12	72	78	1	3-wide	3	UH3228-1	UH3228-1A	PT, HG
12	15	72	78	1	1-wide	1	UH1258-1	UH1258-1A	PT, HG
12	15	72	78	1	3-wide	3	UH3258-1	UH3258-1A	PT, HG
12	18	72	78	1	1-wide	1	UH1288-1	UH1288-1A	PT, HG
12	18	72	78	1	3-wide	3	UH3288-1	UH3288-1A	PT, HG
DOUBLE TIER									
12	12	36	78	2	1-wide	2	UH1228-2	UH1228-2A	PT, HG
12	12	36	78	2	3-wide	6	UH3228-2	UH3228-2A	PT, HG
12	15	36	78	2	1-wide	2	UH1258-2	UH1258-2A	PT, HG
12	15	36	78	2	3-wide	6	UH3258-2	UH3258-2A	PT, HG
12	18	36	78	2	1-wide	2	UH1288-2	UH1288-2A	PT, HG
12	18	36	78	2	3-wide	6	UH3288-2	UH3288-2A	PT, HG
TRIPLE TIER									
12	12	24	78	3	1-wide	3	UH1228-3	UH1228-3A	PT, HG
12	12	24	78	3	3-wide	9	UH3228-3	UH3228-3A	PT, HG
12	15	24	78	3	1-wide	3	UH1258-3	UH1258-3A	PT, HG
12	15	24	78	3	3-wide	9	UH3258-3	UH3258-3A	PT, HG
12	18	24	78	3	1-wide	3	UH1288-3	UH1288-3A	PT, HG
12	18	24	78	3	3-wide	9	UH3288-3	UH3288-3A	PT, HG

STOCK COLOR

729 TAN (PT)

725 DARK GRAY (HG)

LOCKER ACCESSORIES
PAGES 86-87

VALUEMAX™ ECONOMY LOCKERS

MFO!

Modern flush door design with safety-minded recessed handle and reinforced door make our Maintenance-Free™ Quiet KD stock lockers the smart choice.

FEATURES:

BODY CONSTRUCTION: Knock-down, 24 gauge

BODY STYLES: Single, double and triple tier

DOOR: 16 gauge, solid with welded in door stiffener

HINGES: Continuous piano type

HANDLE: Deep drawn stainless steel recessed handle with single-point latching. Recessed handle protects finish from being marred by padlock.

HOOKS: One double prong ceiling hook and two single hooks per single and double tier opening. One double ceiling hook for triple tier.

COAT RODS: Available for single tier at a nominal cost

SHELVES: Hat shelf is included in single tier lockers.

LEGS: 6" high legs are standard. Lockers without legs are available for a nominal charge

MAINTENANCE-FREE™ QUIET KD LOCKERS



Single Tier,
1 wide,
1 opening



Double Tier,
1 wide,
2 openings



Triple Tier,
1 wide,
3 openings



Maintenance-Free Quiet Lockers include a 3" wide 18 gauge full height door stiffener spot welded to the inner door face and MIG welded to the hinge side as well as to the top and bottom door flanges providing a rigid torque-free door.



Deep-drawn 401 stainless steel recessed handle with single-point latching



Single Tier,
3 wide,
3 openings



Triple Tier,
3 wide,
9 openings

2 YEAR WARRANTY

PIANO HINGE STANDARD

CARE-FREE DESIGN
QUIET OPERATION
REINFORCED DOORS



Width	Depth	Opening Height	Frame Height	Tier	Grouping	Openings Per Group	Knock-Down Cat No.	Fully-Assembled Cat No.	Color Selection
SINGLE TIER									
12	12	72	78	1	1-wide	1	UY1228-1	UY1228-1A	PT, HG
12	12	72	78	1	3-wide	3	UY3228-1	UY3228-1A	PT, HG
12	15	72	78	1	1-wide	1	UY1258-1	UY1258-1A	PT, HG
12	15	72	78	1	3-wide	3	UY3258-1	UY3258-1A	PT, HG
12	18	72	78	1	1-wide	1	UY1288-1	UY1288-1A	PT, HG
12	18	72	78	1	3-wide	3	UY3288-1	UY3288-1A	PT, HG
15	15	72	78	1	1-wide	1	UY1558-1	UY1558-1A	PT, HG
15	15	72	78	1	3-wide	3	UY3558-1	UY3558-1A	PT, HG
15	18	72	78	1	1-wide	1	UY1588-1	UY1588-1A	PT, HG
15	18	72	78	1	3-wide	3	UY3588-1	UY3588-1A	PT, HG
15	21	72	78	1	1-wide	1	UY1518-1	UY1518-1A	PT, HG
15	21	72	78	1	3-wide	3	UY3518-1	UY3518-1A	PT, HG
15	24	72	78	1	1-wide	1	UY1548-1	UY1548-1A	PT, HG
15	24	72	78	1	3-wide	3	UY3548-1	UY3548-1A	PT, HG
18	18	72	78	1	1-wide	1	UY1888-1	UY1888-1A	PT, HG
18	18	72	78	1	3-wide	3	UY3888-1	UY3888-1A	PT, HG
18	21	72	78	1	1-wide	1	UY1818-1	UY1818-1A	PT, HG
18	21	72	78	1	3-wide	3	UY3818-1	UY3818-1A	PT, HG
18	24	72	78	1	1-wide	1	UY1848-1	UY1848-1A	PT, HG
18	24	72	78	1	3-wide	3	UY3848-1	UY3848-1A	PT, HG
DOUBLE TIER									
12	12	36	78	2	1-wide	2	UY1228-2	UY1228-2A	PT, HG
12	12	36	78	2	3-wide	6	UY3228-2	UY3228-2A	PT, HG
12	15	36	78	2	1-wide	2	UY1258-2	UY1258-2A	PT, HG
12	15	36	78	2	3-wide	6	UY3258-2	UY3258-2A	PT, HG
12	18	36	78	2	1-wide	2	UY1288-2	UY1288-2A	PT, HG
12	18	36	78	2	3-wide	6	UY3288-2	UY3288-2A	PT, HG
15	15	36	78	2	1-wide	2	UY1558-2	UY1558-2A	PT, HG
15	15	36	78	2	3-wide	6	UY3558-2	UY3558-2A	PT, HG
15	18	36	78	2	1-wide	2	UY1588-2	UY1588-2A	PT, HG
15	18	36	78	2	3-wide	6	UY3588-2	UY3588-2A	PT, HG
15	21	36	78	2	1-wide	2	UY1518-2	UY1518-2A	PT, HG
15	21	36	78	2	3-wide	6	UY3518-2	UY3518-2A	PT, HG
15	24	36	78	2	1-wide	2	UY1548-2	UY1548-2A	PT, HG
15	24	36	78	2	3-wide	6	UY3548-2	UY3548-2A	PT, HG
18	18	36	78	2	1-wide	2	UY1888-2	UY1888-2A	PT, HG
18	18	36	78	2	3-wide	6	UY3888-2	UY3888-2A	PT, HG
18	21	36	78	2	1-wide	2	UY1818-2	UY1818-2A	PT, HG
18	21	36	78	2	3-wide	6	UY3818-2	UY3818-2A	PT, HG
18	24	36	78	2	1-wide	2	UY1848-2	UY1848-2A	PT, HG
18	24	36	78	2	3-wide	6	UY3848-2	UY3848-2A	PT, HG
TRIPLE TIER									
12	12	24	78	3	1-wide	3	UY1228-3	UY1228-3A	PT, HG
12	12	24	78	3	3-wide	9	UY3228-3	UY3228-3A	PT, HG
12	15	24	78	3	1-wide	3	UY1258-3	UY1258-3A	PT, HG
12	15	24	78	3	3-wide	9	UY3258-3	UY3258-3A	PT, HG
12	18	24	78	3	1-wide	3	UY1288-3	UY1288-3A	PT, HG
12	18	24	78	3	3-wide	9	UY3288-3	UY3288-3A	PT, HG

MAINTENANCE-FREE™ QUIET KD LOCKERS



LOCKER ACCESSORIES
PAGES 86-87



Locks arrive in Day-Use mode for shared use and can be programmed for permanent use by management.

DIGITECH™ ELECTRONIC ACCESS LOCKERS



Single Tier,
1 wide,
1 opening



Double Tier,
1 wide,
2 openings



Single Tier,
3 wide,
3 openings



Six Tier,
3 wide,
18 openings

FEATURES:

BODY CONSTRUCTION: Knock-down, 24 gauge

BODY STYLES: Single, double, triple and six tier

DOOR: 16 gauge, louvered type, 18 gauge for box doors

LATCHING: Single-point

HINGES: Continuous piano type

HANDLE: User programmable electronic lock/handle, single-point latching

HOOKS: One double prong ceiling hook and two single hooks per single and double tier opening. One double ceiling hook for triple tier. No hooks for 6 tier

COAT RODS: Available for single tier at a nominal cost

SHELVES: Hat shelf is included in single tier lockers.

LEGS: 6" high legs are standard. Lockers without legs are available for a nominal charge.

2 YEAR WARRANTY

PIANO HINGE STANDARD

PERFECT FOR BOTH SHARED AND
PERMANENT USE



Hallowell
Hallowell-List.com



LOCK FEATURES:

- Powered by 1 CR123 batteries which provide in excess of 10,000 uses.
- 1 CR123 battery is included.
- LED's flash to indicate low battery level.
- Locker can be opened when batteries are low or dead by using the Master Key override.
- 8-digit master and sub-master codes for two levels of management security.

DAY-USE MODE:

- User can lock and unlock any available locker door with a user selected 4-digit code.
- Upon returning, user enters the 4-digit code to unlock the door. Code is erased and the locker is available for the next user.

PERMANENT MODE:

- User enters a pre-programmed 4-digit code to unlock and use locker repeatedly.
- Lock does not require a code to re-lock door.



DIGITECH™ ELECTRONIC ACCESS LOCKERS

Width	Depth	Opening Height	Frame Height	Tier	Grouping	Openings Per Group	Knock-Down Cat No.	Fully-Assembled Cat No.	Color Selection
SINGLE TIER									
12	12	72	78	1	1-wide	1	UEL1228-1	UEL1228-1A	PT
12	12	72	78	1	3-wide	3	UEL3228-1	UEL3228-1A	PT
12	15	72	78	1	1-wide	1	UEL1258-1	UEL1258-1A	PT
12	15	72	78	1	3-wide	3	UEL3258-1	UEL3258-1A	PT
12	18	72	78	1	1-wide	1	UEL1288-1	UEL1288-1A	PT
12	18	72	78	1	3-wide	3	UEL3288-1	UEL3288-1A	PT
DOUBLE TIER									
12	12	36	78	2	1-wide	2	UEL1228-2	UEL1228-2A	PT
12	12	36	78	2	3-wide	6	UEL3228-2	UEL3228-2A	PT
12	15	36	78	2	1-wide	2	UEL1258-2	UEL1258-2A	PT
12	15	36	78	2	3-wide	6	UEL3258-2	UEL3258-2A	PT
12	18	36	78	2	1-wide	2	UEL1288-2	UEL1288-2A	PT
12	18	36	78	2	3-wide	6	UEL3288-2	UEL3288-2A	PT
TRIPLE TIER									
12	12	24	78	3	1-wide	3	UEL1228-3	UEL1228-3A	PT
12	12	24	78	3	3-wide	9	UEL3228-3	UEL3228-3A	PT
12	15	24	78	3	1-wide	3	UEL1258-3	UEL1258-3A	PT
12	15	24	78	3	3-wide	9	UEL3258-3	UEL3258-3A	PT
12	18	24	78	3	1-wide	3	UEL1288-3	UEL1288-3A	PT
12	18	24	78	3	3-wide	9	UEL3288-3	UEL3288-3A	PT
SIX TIER									
12	12	12	78	6	1-wide	6	UEL1228-6	UEL1228-6A	PT
12	12	12	78	6	3-wide	18	UEL3228-6	UEL3228-6A	PT
12	15	12	78	6	1-wide	6	UEL1258-6	UEL1258-6A	PT
12	15	12	78	6	3-wide	18	UEL3258-6	UEL3258-6A	PT
12	18	12	78	6	1-wide	6	UEL1288-6	UEL1288-6A	PT
12	18	12	78	6	3-wide	18	UEL3288-6	UEL3288-6A	PT



729
TAN (PT)



5 DAY SHIPPING ON ALL IN-STOCK PRODUCTS

SAFETY-VIEW® LOCKERS



Clear Polycarbonate Door Inserts

Double Tier, 3 wide, 6 openings

KD WARDROBE LOCKERS
SAFETY VIEW™

WARDROBE LOCKER FEATURES:

BODY CONSTRUCTION: Knock-down, 24 gauge

BODY STYLES: Single, double and triple tier

DOOR: 16 gauge steel with two high strength injection molded polycarbonate panels per door for easy content viewing

HINGES: Continuous piano type

HANDLE: Stainless steel recessed handle with multi-point gravity lift-type latching. Recessed handle protects finish from being marred by padlock.

HOOKS: One double prong ceiling hook and two single hooks per single and double tier opening. One double ceiling hook for triple tier

COAT RODS: Available for single tier at a nominal cost

SHELVES: Hat shelf is included in single tier lockers

LEGS: 6" high legs are standard. Lockers without legs are available for a nominal charge.

ANTIMICROBIAL PROTECTION

UPGRADED Antimicrobial Recessed Handle Finger Lift Cover

All gravity lift-type latching lockers that include recessed handles include our Antimicrobial Recessed Handle Finger Lift Cover for protection against the growth of molds and bacteria



PIANO HINGE STANDARD

2 YEAR WARRANTY

STOCK COLOR

729 TAN (PT)

LOCKER ACCESSORIES PAGES 86-87

Width	Depth	Opening Height	Frame Height	Tier	Grouping	Openings Per Group	Knock-Down Cat No.	Fully-Assembled Cat No.	Color Selection
SINGLE TIER									
12	12	72	78	1	1-wide	1	USV1228-1	USV1228-1A	PT
12	12	72	78	1	3-wide	3	USV3228-1	USV3228-1A	PT
12	15	72	78	1	1-wide	1	USV1258-1	USV1258-1A	PT
12	15	72	78	1	3-wide	3	USV3258-1	USV3258-1A	PT
12	18	72	78	1	1-wide	1	USV1288-1	USV1288-1A	PT
12	18	72	78	1	3-wide	3	USV3288-1	USV3288-1A	PT
DOUBLE TIER									
12	12	36	78	2	1-wide	2	USV1228-2	USV1228-2A	PT
12	12	36	78	2	3-wide	6	USV3228-2	USV3228-2A	PT
12	15	36	78	2	1-wide	2	USV1258-2	USV1258-2A	PT
12	15	36	78	2	3-wide	6	USV3258-2	USV3258-2A	PT
12	18	36	78	2	1-wide	2	USV1288-2	USV1288-2A	PT
12	18	36	78	2	3-wide	6	USV3288-2	USV3288-2A	PT
TRIPLE TIER									
12	12	24	78	3	1-wide	3	USV1228-3	USV1228-3A	PT
12	12	24	78	3	3-wide	9	USV3228-3	USV3228-3A	PT
12	15	24	78	3	1-wide	3	USV1258-3	USV1258-3A	PT
12	15	24	78	3	3-wide	9	USV3258-3	USV3258-3A	PT
12	18	24	78	3	1-wide	3	USV1288-3	USV1288-3A	PT
12	18	24	78	3	3-wide	9	USV3288-3	USV3288-3A	PT

CLEAR DOORS FOR UNOBSTRUCTED VIEWING



Hallowell
Hallowell-List.com

KD BOX LOCKERS

SAFETY VIEW™ PLUS

BOX LOCKER FEATURES:

BODY CONSTRUCTION: Knock-down, 24 gauge

BODY STYLES: Four tier, six tier, sixteen person and wall mount

DOOR: High strength injection molded clear polycarbonate doors for unobstructed content viewing

HINGES: Continuous piano type

HANDLE: Single-point projecting friction catch door pull prepared for both padlock or built-in lock

COAT RODS: Standard on Sixteen person

LEGS: 6" high legs are standard. Lockers without legs are available for a nominal charge

GENERAL FEATURES:

- Aluminum number plates (#1-up) with mounting hardware are included.
- Locks are not included.
- Safety-View plus doors provide an unobstructed view of locker contents
- Can be ordered fully-assembled or knock-down for assembly at destination
- Order 3-wide units for best value. Order 1-wide units to complete quantity needed for each continuous row



UPGRADED Antimicrobial Box Door Finger Pulls

All box door finger pulls are made of a super tough nylon material which includes an Antimicrobial agent offering protection against the growth of molds and bacteria.



Clear Polycarbonate Doors

Six-tier, 3 wide, 18 openings

SAFETY-VIEW™ PLUS LOCKERS

Width	Depth	Opening Height	Frame Height	Tier	Grouping	Openings Per Group	Knock-Down Cat No.	Fully-Assembled Cat No.	Color Selection
FOUR TIER									
12	12	18	78	4	1-wide	4	USVP1228-4	USVP1228-4A	PT
12	12	18	78	4	3-wide	12	USVP3228-4	USVP3228-4A	PT
12	15	18	78	4	1-wide	4	USVP1258-4	USVP1258-4A	PT
12	15	18	78	4	3-wide	12	USVP3258-4	USVP3258-4A	PT
12	18	18	78	4	1-wide	4	USVP1288-4	USVP1288-4A	PT
12	18	18	78	4	3-wide	12	USVP3288-4	USVP3288-4A	PT
FIVE TIER									
12	12	12	66	5	1-wide	5	USVP1226-5	USVP1226-5A	PT
12	12	12	66	5	3-wide	15	USVP3226-5	USVP3226-5A	PT
12	15	12	66	5	1-wide	5	USVP1256-5	USVP1256-5A	PT
12	15	12	66	5	3-wide	15	USVP3256-5	USVP3256-5A	PT
12	18	12	66	5	1-wide	5	USVP1286-5	USVP1286-5A	PT
12	18	12	66	5	3-wide	15	USVP3286-5	USVP3286-5A	PT
SIX TIER									
12	12	12	78	6	1-wide	6	USVP1228-6	USVP1228-6A	PT
12	12	12	78	6	3-wide	18	USVP3228-6	USVP3228-6A	PT
12	15	12	78	6	1-wide	6	USVP1258-6	USVP1258-6A	PT
12	15	12	78	6	3-wide	18	USVP3258-6	USVP3258-6A	PT
12	18	12	78	6	1-wide	6	USVP1288-6	USVP1288-6A	PT
12	18	12	78	6	3-wide	18	USVP3288-6	USVP3288-6A	PT
4-WIDE WALL MOUNT									
48	18	12	14-3/4	4-Wide Wall Mount		4	USVP1482-4WM	USVP1482-4WMA	PT
16-PERSON									
72	18	12	78	16-Person Unit		16	USVP1788-16	USVP1788-16A	PT

STOCK COLOR
729 TAN (PT)

PIANO HINGE STANDARD

2 YEAR WARRANTY

LOCKER ACCESSORIES PAGES 86-87

5 DAY SHIPPING ON ALL IN-STOCK PRODUCTS



Four Tier,
3 wide,
12 openings

DigiTech Safety-View Plus Box Lockers



SAFETY VIEW PLUS

BOX LOCKER FEATURES:

BODY CONSTRUCTION: Knock-down, 24 gauge

BODY STYLES: Four tier, six tier, sixteen person and wall mount

DOOR: High strength injection molded clear polycarbonate doors for unobstructed content viewing

HINGES: Continuous piano type

HANDLE: DigiTech lock serves as door pull when in the open position

HOOKS: None

COAT RODS: Standard on Sixteen person

SHELVES: None

LEGS: 6" high legs are standard. Lockers without legs are available for a nominal charge

GENERAL FEATURES:

- Aluminum number plates (#1-up) with mounting hardware are included
- DigiTech Locks and 1 CR123 batteries included
- Safety-View plus doors provide an unobstructed view of locker contents
- Can be ordered fully-assembled or knock-down for assembly at destination
- Order 3-wide units for best value. Order 1-wide units to complete quantity needed for each continuous row
- Available for immediate shipping

Digitech
Electronic
Access
Lock



Clear Polycarbonate
Doors Provide View of
Locker Contents



2 YEAR WARRANTY

PIANO HINGE STANDARD

ELECTRONIC ACCESS SEE THRU DOORS



Hallowell
Hallowell-List.com



LOCK FEATURES:

- Powered by 1 CR123 batteries which provide in excess of 10,000 uses.
- 1 CR123 batteries are included.
- LED's flash to indicate low battery level.
- Locker can be opened when batteries are low or dead by using the Master Key override.
- 8-digit master and sub-master codes for two levels of management security.

DAY-USE MODE:

- User can lock and unlock any available locker door with a user selected 4-digit code.
- Upon returning, user enters the 4-digit code to unlock the door. Code is erased and the locker is available for the next user.

PERMANENT MODE:

- User enters a pre-programmed 4-digit code to unlock and use locker repeatedly.
- Lock does not require a code to re-lock door.



DIGITECH SAFETY-VIEW PLUS BOX LOCKERS

Width	Depth	Opening Height	Frame Height	Tier	Grouping	Openings Per Group	Knock-Down Cat No.	Fully-Assembled Cat No.	Color Selection
FOUR TIER									
12	12	18	78	4	1-wide	4	UESVP1228-4	UESVP1228-4A	PT
12	12	18	78	4	3-wide	12	UESVP3228-4	UESVP3228-4A	PT
12	15	18	78	4	1-wide	4	UESVP1258-4	UESVP1258-4A	PT
12	15	18	78	4	3-wide	12	UESVP3258-4	UESVP3258-4A	PT
12	18	18	78	4	1-wide	4	UESVP1288-4	UESVP1288-4A	PT
12	18	18	78	4	3-wide	12	UESVP1288-4	UESVP1288-4A	PT
SIX TIER									
12	12	12	78	6	1-wide	6	UESVP1228-6	UESVP1228-6A	PT
12	12	12	78	6	3-wide	18	UESVP3228-6	UESVP3228-6A	PT
12	15	12	78	6	1-wide	6	UESVP1258-6	UESVP1258-6A	PT
12	15	12	78	6	3-wide	18	UESVP3258-6	UESVP3258-6A	PT
12	18	12	78	6	1-wide	6	UESVP1288-6	UESVP1288-6A	PT
12	18	12	78	6	3-wide	18	UESVP1288-6	UESVP1288-6A	PT
4-WIDE WALL MOUNT									
48	18	12	14-3/4	4-Wide Wall Mount		4	UESVP1482-4WM	UESVP1482-4WMA	PT
16-PERSON UNIT									
72	18	12	78	16-Person Unit		16	UESVP1788-16	UESVP1788-16A	PT



729
TAN (PT)



5 DAY SHIPPING ON ALL IN-STOCK PRODUCTS

Heavy-Duty Ventilated (HDV) KD Stock Lockers

HEAVY-DUTY VENTILATED (HDV) LOCKERS



- ✓ Ventilated doors and sides
- ✓ Heavy gauge door and body
- ✓ Large capacity sizes available
- ✓ Strength and ventilation in one practical locker

3X MORE STEEL
THAN CONVENTIONAL LOCKERS



Double Tier,
1 wide,
2 openings



Six Tier,
3 wide,
18 openings



Double Tier,
3 wide,
6 opening



Six Tier,
1 wide,
6 openings



Six Tier,
1 wide,
6 openings



Single Tier,
1 wide,
1 opening



UPGRADED Antimicrobial Recessed Handle Finger Lift Cover & Box Door Finger Pulls

Lift covers and finger pulls are made of a super tough nylon material which includes an Antimicrobial agent offering protection against the growth of molds and bacteria.



2 YEAR WARRANTY

PIANO HINGE STANDARD

WHEN STRENGTH AND VENTILATION MATTER



Hallowell
Hallowell-List.com

FEATURES:

BODY CONSTRUCTION: Knock-down, 16 gauge body with 18 gauge back. Sides are diamond perforated for maximum ventilation

BODY STYLES: Single, double and six tier

DOOR: 14 gauge, diamond perforated for maximum ventilation

HINGES: Continuous piano type

HANDLE (wardrobe): Stainless steel recessed handle with multi-point gravity lift-type latching. Recessed handle protects finish from being marred by padlock.

HANDLE (box): Box lockers include a projecting single-point friction catch door pull prepared for both padlock or built-in lock. No moving parts insures quiet maintenance-free operation.

HOOKS: One double prong ceiling hook and two single hooks per single and double tier opening. One double ceiling hook for triple tier.

COAT RODS: Available for single tier at a nominal cost

SHELVES: Hat shelf is included in single tier lockers.

LEGS: 6" high legs are standard. Lockers without legs are available for a nominal charge.



Single Tier,
1 wide,
1 opening



Single Tier,
1 wide,
1 opening

Width	Depth	Height	Opening Height	Tier	Frame Grouping	Openings Per Group	Knock-down Cat No.	Fully-Assembled Cat No.	Color Selection
SINGLE TIER									
12	12	72	78	1	1-wide	1	U1228-1HDV	U1228-1HV-A	PT, HG
12	12	72	78	1	3-wide	3	U3228-1HDV	U3228-1HV-A	PT, HG
12	15	72	78	1	1-wide	1	U1258-1HDV	U1258-1HV-A	PT, HG
12	15	72	78	1	3-wide	3	U3258-1HDV	U3258-1HV-A	PT, HG
12	18	72	78	1	1-wide	1	U1288-1HDV	U1288-1HV-A	PT, HG
12	18	72	78	1	3-wide	3	U3288-1HDV	U3288-1HV-A	PT, HG
15	15	72	78	1	1-wide	1	U1558-1HDV	U1558-1HV-A	PT, HG
15	15	72	78	1	3-wide	3	U3558-1HDV	U3558-1HV-A	PT, HG
15	18	72	78	1	1-wide	1	U1588-1HDV	U1588-1HV-A	PT, HG
15	18	72	78	1	3-wide	3	U3588-1HDV	U3588-1HV-A	PT, HG
15	21	72	78	1	1-wide	1	U1518-1HDV	U1518-1HV-A	PT, HG
15	21	72	78	1	3-wide	3	U3518-1HDV	U3518-1HV-A	PT, HG
18	18	72	78	1	1-wide	1	U1888-1HDV	U1888-1HV-A	PT, HG
18	18	72	78	1	3-wide	3	U3888-1HDV	U3888-1HV-A	PT, HG
18	21	72	78	1	1-wide	1	U1818-1HDV	U1818-1HV-A	PT, HG
18	21	72	78	1	3-wide	3	U3818-1HDV	U3818-1HV-A	PT, HG
DOUBLE TIER									
12	12	36	78	2	1-wide	2	U1228-2HDV	U1228-2HV-A	PT, HG
12	12	36	78	2	3-wide	6	U3228-2HDV	U3228-2HV-A	PT, HG
12	15	36	78	2	1-wide	2	U1258-2HDV	U1258-2HV-A	PT, HG
12	15	36	78	2	3-wide	6	U3258-2HDV	U3258-2HV-A	PT, HG
12	18	36	78	2	1-wide	2	U1288-2HDV	U1288-2HV-A	PT, HG
12	18	36	78	2	3-wide	6	U3288-2HDV	U3288-2HV-A	PT, HG
15	15	36	78	2	1-wide	2	U1558-2HDV	U1558-2HV-A	PT, HG
15	15	36	78	2	3-wide	6	U3558-2HDV	U3558-2HV-A	PT, HG
15	18	36	78	2	1-wide	2	U1588-2HDV	U1588-2HV-A	PT, HG
15	18	36	78	2	3-wide	6	U3588-2HDV	U3588-2HV-A	PT, HG
15	21	36	78	2	1-wide	2	U1518-2HDV	U1518-2HV-A	PT, HG
15	21	36	78	2	3-wide	6	U3518-2HDV	U3518-2HV-A	PT, HG
18	18	36	78	2	1-wide	2	U1888-2HDV	U1888-2HV-A	PT, HG
18	18	36	78	2	3-wide	6	U3888-2HDV	U3888-2HV-A	PT, HG
18	21	36	78	2	1-wide	2	U1818-2HDV	U1818-2HV-A	PT, HG
18	21	36	78	2	3-wide	6	U3818-2HDV	U3818-2HV-A	PT, HG
SIX TIER									
12	12	12	78	6	1-wide	6	U1228-6HDV	U1228-6HV-A	PT, HG
12	12	12	78	6	3-wide	18	U3228-6HDV	U3228-6HV-A	PT, HG
12	15	12	78	6	1-wide	6	U1258-6HDV	U1258-6HV-A	PT, HG
12	15	12	78	6	3-wide	18	U3258-6HDV	U3258-6HV-A	PT, HG
12	18	12	78	6	1-wide	6	U1288-6HDV	U1288-6HV-A	PT, HG
12	18	12	78	6	3-wide	18	U3288-6HDV	U3288-6HV-A	PT, HG



LOCKER ACCESSORIES
PAGES 86-87

HEAVY-DUTY VENTILATED (HDV) LOCKERS

5 DAY SHIPPING ON ALL IN-STOCK PRODUCTS

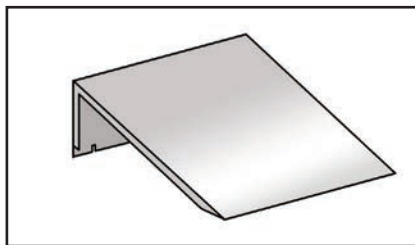

INDIVIDUAL SLOPE TOPS

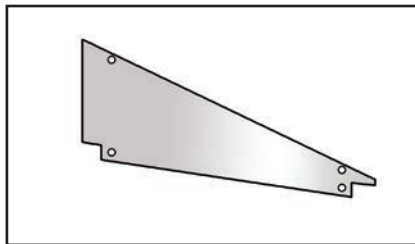

END CLOSURES
FOR INDIVIDUAL SLOPE TOPS

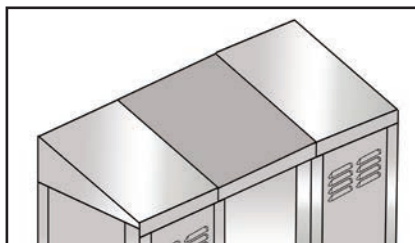

SLOPE TOP FILLER

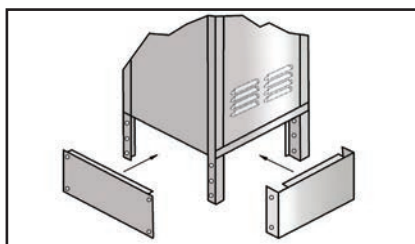

CLOSED FRONT AND SIDE BASE

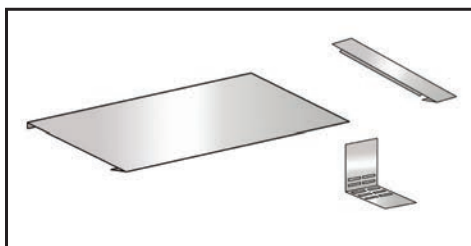

CONTINUOUS SLOPE TOP

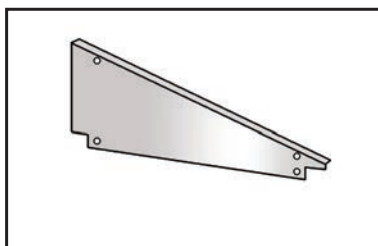

END CLOSURES
FOR CONTINUOUS SLOPE TOPS

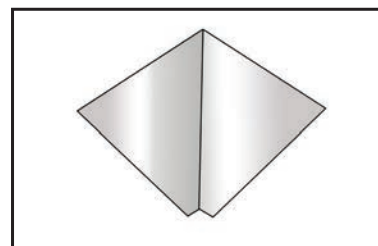

SLOPE TOP CORNER

Width	Depth	Height	Cat No.	Color Selection
INDIVIDUAL SLOPE TOPS				
12	12	4	KISTT1212	PT, HG, MB, ME, PL
12	15	5	KISTT1215	PT, HG, MB, ME, PL
12	18	6	KISTT1218	PT, HG, MB, ME, PL
15	15	5	KISTT1515	PT, HG
15	18	6	KISTT1518	PT, HG
15	21	7	KISTT1521	PT
18	18	6	KISTT1818	PT, HG
18	21	7	KISTT1821	PT, HG
18	24	8	KISTT1824	PT
END CLOSURES (FOR INDIVIDUAL SLOPE TOPS)				
	12	4	KISE12	PT, HG, MB, ME, PL
	15	5	KISE15	PT, HG, MB, ME, PL
	18	6	KISE18	PT, HG, MB, ME, PL
	21	7	KISE21	PT, HG
	24	8	KISE24	PT
SLOPE TOP FILLER (FOR INDIVIDUAL SLOPE TOPS)				
6	12	4	KSTF0612	PT, HG, MB, ME, PL
6	15	5	KSTF0615	PT, HG, MB, ME, PL
6	18	6	KSTF0618	PT, HG, MB, ME, PL
12	12	4	KSTF1212	PT, HG, MB, ME, PL
12	15	5	KSTF1215	PT, HG, MB, ME, PL
12	18	6	KSTF1218	PT, HG, MB, ME, PL
CONTINUOUS SLOPE TOP				
72	12	4	CST1272	PT, HG, MB, ME, PL
72	15	5	CST1572	PT, HG, MB, ME, PL
72	18	6	CST1872	PT, HG, MB, ME, PL
END CLOSURES (FOR CONTINUOUS SLOPE TOP)				
	12	4	WCSE12	PT, HG, MB, ME, PL
	15	5	WCSE15	PT, HG, MB, ME, PL
	18	6	WCSE18	PT, HG, MB, ME, PL
SLOPE TOP CORNER				
	12	12	STC12	PT, HG, MB, ME, PL
	15	15	STC15	PT, HG, MB, ME, PL
	18	18	STC18	PT, HG, MB, ME, PL
CLOSED FRONT BASE				
12		6	KCFB12	PT, HG, MB, ME, PL
15		6	KCFB15	PT, HG
18		6	KCFB18	PT, HG
CLOSED SIDE BASE				
12		6	KCSB12	PT, HG, MB, ME, PL
15		6	KCSB15	PT, HG, MB, ME, PL
18		6	KCSB18	PT, HG, MB, ME, PL
21		6	KCSB21	PT, HG
24		6	KCSB24	PT

Accessories work with lockers shown on pages 66-73 and 75-85.
Not compatible with 16-person or 4 wide wall-mount lockers.



729
TAN (PT)

707
MARINE BLUE (MB)

725
DARK Gray (HG)

708
BLACK (ME)

711
LIGHT GRAY (PL)

COMPLETE SELECTION OF STOCK KD LOCKER ACCESSORIES



Hallowell
Hallowell-List.com

Width	Depth	Height	Cat. No.	Color Selection
Z-BASE FRONTS				
72		4	KZBF-N	PT, HG, MB, ME, PL
Z-BASE ENDS				
	12	4	KZBE12-N	PT, HG, MB, ME, PL
	15	4	KZBE15-N	PT, HG, MB, ME, PL
	18	4	KZBE18-N	PT, HG, MB, ME, PL
Z-BASE SPLICE				
3			KZBS-N	PT
TOP RECESSED TRIM				
72		3	KRT-T	PT, HG, MB, ME, PL
TOP RECESSED TRIM SPLICE				
3		3	KRT-SC	PT, HG, MB, ME, PL
SIDE RECESS TRIM				
3		63	KRT60L	PT
3		63	KRT60R	PT
3		75	KRT72L	PT, HG, MB, ME, PL
3		75	KRT72R	PT, HG, MB, ME, PL
COAT RODS				
12			KCR12	Plated
15			KCR15	Plated
18			KCR18	Plated
21			KCR21	Plated
24			KCR24	Plated
7.5	(For Duplex and Two-Person only)		KCR15L	Plated
7.5	(For Duplex and Two-Person only)		KCR15R	Plated
FRONT FILLERS				
6		66	KFSF0666	PT
12		66	KFSF1266	PT
6		78	KFSF0678	PT, HG, MB, ME, PL
12		78	KFSF1278	PT, HG, MB, ME, PL
FILLER SLIP JOINTS				
		66	KG66	PT
		78	KG78	PT, HG, MB, ME, PL
UNIVERSAL ANGLE				
1	2	72	AF010272	PT
FLAT TOP FILLERS				
6	12		KFTF0612	PT, HG, MB, ME, PL
6	15		KFTF0615	PT, HG, MB, ME, PL
6	18		KFTF0618	PT, HG, MB, ME, PL
12	12		KFTF1212	PT, HG, MB, ME, PL
12	15		KFTF1215	PT, HG, MB, ME, PL
12	18		KFTF1218	PT, HG, MB, ME, PL
FLAT TOP CORNER				
12	12		FTC12	PT, HG, MB, ME, PL
15	15		FTC15	PT, HG, MB, ME, PL
18	18		FTC18	PT, HG, MB, ME, PL
UNIVERSAL END PANELS				
	12	60	KMP1260	PT, HG
	15	60	KMP1560	PT, HG
	18	60	KMP1860	PT, HG
	12	72	KMP1272	PT, HG, MB, ME, PL
	15	72	KMP1572	PT, HG, MB, ME, PL
	18	72	KMP1872	PT, HG, MB, ME, PL
	21	72	KMP2172	PT, HG
	24	72	KMP2472	PT

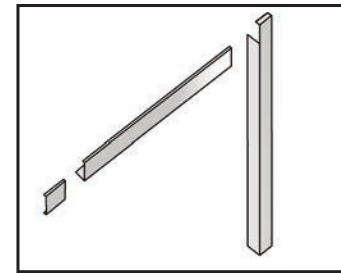

RECESSED TRIM

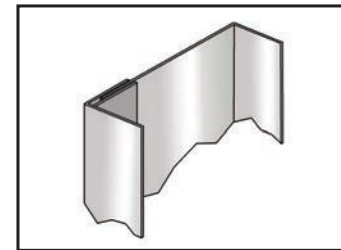

FRONT FILLER AND SLIPJOINT

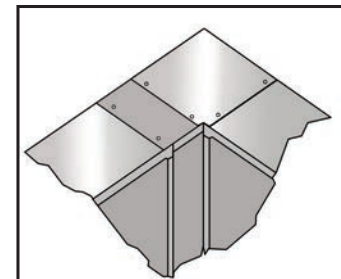

FLAT TOP FILLER

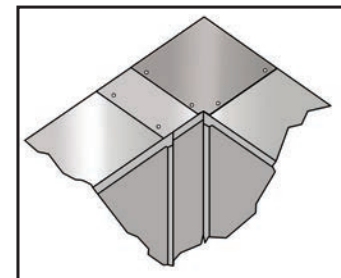

FLAT TOP CORNER

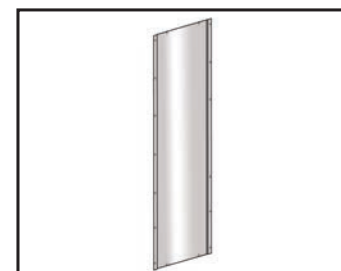

FINISHED END PANEL

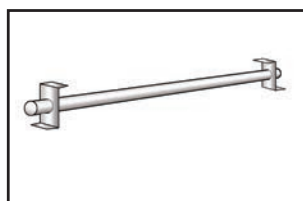

COAT RODS W/ HOLDERS

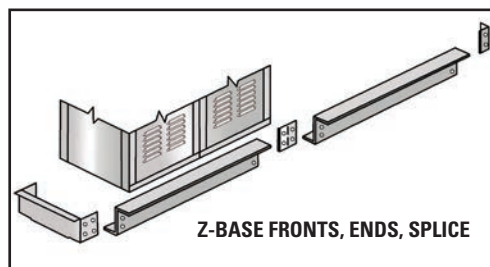

Z-BASE FRONTS, ENDS, SPLICE

ACCESSORY SELECTION

5 DAY SHIPPING ON ALL IN-STOCK PRODUCTS

HALLOWELL
HYBRID LOCKERS
WOOD/METAL

FEATURES:

BODY CONSTRUCTION: Knock-down, 24 gauge sheet steel

BODY STYLES: Single, double and triple tier

DOOR: Furniture grade red oak plywood, finished with 2 coats of lacquer

HINGES: Continuous piano type

HOOKS: Two single hooks per single and double tier opening. One double prong ceiling hook for triple tier.

COAT RODS: Standard for single and double tier

SHELVES: Hat shelf in single tier lockers only.

LEGS: 6" high legs are standard. Lockers without legs are available at a nominal charge legs appearance:

COLOR: black frame with red oak door

NOTE: Other optional locking methods also available



GENERAL FEATURES:

- Lockers can be ordered fully-assembled or knock-down for assembly at destination.
- Order 3-wide units for best value. Order 1-wide units to complete quantity needed for each continuous row.
- Aluminum number plates (#1-up) with mounting hardware are included. Number plate face is black with silver etched numerals. If a special numbering sequence is required, please specify when ordering. Number sequence must be consecutive numbers equal to the number of openings (doors) ordered.
- Built-in key locks are included.



1 YEAR WARRANTY

THE PRESTIGE OF FINE WOOD, THE AFFORDABLE PRICE OF METAL KD LOCKERS

Red Oak Doors and Steel Frame & Body
All lockers shown with optional closed metal base



WOOD-METAL WARDROBE LOCKERS

Width	Depth	Height	Opening Height	Tier	Frame Grouping	Openings Per Group	Knock-down Cat No.	Fully-Assembled Cat No.	Color Selection
SINGLE TIER									
12	18	72	78	1	1-wide	1	UW1288-1MEW	UW1288-1A-MEW	ME/Wood
12	18	72	78	1	3-wide	3	UW3288-1MEW	UW3288-1A-MEW	ME/Wood
15	18	72	78	1	1-wide	1	UW1588-1MEW	UW1588-1A-MEW	ME/Wood
15	18	72	78	1	3-wide	3	UW3588-1MEW	UW3588-1A-MEW	ME/Wood
DOUBLE TIER									
12	18	36	78	2	1-wide	2	UW1288-2MEW	UW1288-2A-MEW	ME/Wood
12	18	36	78	2	3-wide	6	UW3288-2MEW	UW3288-2A-MEW	ME/Wood
15	18	36	78	2	1-wide	2	UW1588-2MEW	UW1588-2A-MEW	ME/Wood
15	18	36	78	2	3-wide	6	UW3588-2MEW	UW3588-2A-MEW	ME/Wood
TRIPLE TIER									
12	18	24	78	3	1-wide	3	UW1288-3MEW	UW1288-3A-MEW	ME/Wood
12	18	24	78	3	3-wide	9	UW3288-3MEW	UW3288-3A-MEW	ME/Wood

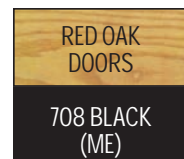

Accessories			
CLOSED FRONT BASES			
12	6	KCFB12ME	ME
15	6	KCFB15ME	ME
CLOSED SIDE BASES			
18	6	KCSB18ME	ME

 LOCKER ACCESSORIES PAGES 86-87

5 DAY SHIPPING ON ALL IN-STOCK PRODUCTS

Club Lockers

FEATURES:

BODY CONSTRUCTION: Wood lockers shall be fabricated from 3/4" plain sliced red oak plywood throughout including sides, backs and hat shelves.

BODY STYLES: Single, double and triple tier

FINISH: All interior/front faces to be finished with a three coat catalyzed clear cabinet lacquer or equivalent.

DOOR: Furniture grade red oak plywood, finished with 3 coats of lacquer

HINGES: Concealed European-style cabinet hinges

HOOKS: Two single hooks per single and double tier opening. One double prong ceiling hook for triple tier.

COAT RODS: Standard for single and double tier

SHELVES: Hat shelf is included in single tier lockers.

LEGS: No legs

APPEARANCE: Natural red oak

NOTE: Other optional locking methods also available

WOOD WARDROBE LOCKERS



Single tier,
1 wide
Shown with
optional finished
end panels



Double tier,
1 wide
Shown with
optional finished
end panels, base
and crown molding



Triple tier,
1 wide
Shown with
optional finished
end panels



Available optional decorative crown molding and base in red oak finish



Concealed European style cabinet door hinges



Key locks are standard

1 YEAR WARRANTY

STOCK COLOR

RED OAK

IDEAL FOR COUNTRY CLUBS, HEALTH SPAS AND FITNESS CENTERS



Single tier, 3 wide, 3 openings
Shown with optional finished end panels,
base and decorative crown molding

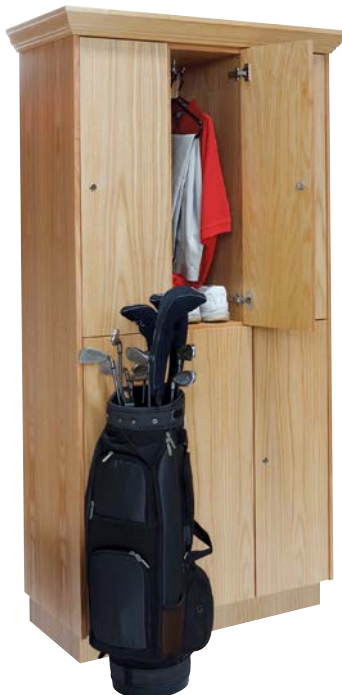

Double tier, 3 wide, 6 openings
Shown with optional finished end panels,
base and decorative crown molding



Triple tier, 3 wide, 9 openings
Shown with optional finished end panels,
base and decorative crown molding



Width	Depth	Opening Height	Frame Height	Tier	Grouping	Openings Per Group	Fully-Assembled Cat No.	Color Selection
SINGLE TIER								
12	18	72	72	1	1-wide	1	UW1282-1A-W	Red Oak
12	18	72	72	1	3-wide	3	UW3282-1A-W	Red Oak
15	18	72	72	1	1-wide	1	UW1582-1A-W	Red Oak
15	18	72	72	1	3-wide	3	UW3582-1A-W	Red Oak
DOUBLE TIER								
12	18	36	72	2	1-wide	2	UW1282-2A-W	Red Oak
12	18	36	72	2	3-wide	6	UW3282-2A-W	Red Oak
15	18	36	72	2	1-wide	2	UW1582-2A-W	Red Oak
15	18	36	72	2	3-wide	6	UW3582-2A-W	Red Oak
TRIPLE TIER								
12	18	24	72	3	1-wide	3	UW1282-3A-W	Red Oak
12	18	24	72	3	3-wide	9	UW3282-3A-W	Red Oak
15	18	24	72	3	1-wide	3	UW1582-3A-W	Red Oak
15	18	24	72	3	3-wide	9	UW3588-3A-W	Red Oak

Accessories			Catalog No.	Color Selection
Width	Depth	Height		
BASE				
12	18	4	WCB128W	Red Oak
36	18	4	WCB328W	Red Oak
15	18	4	WCB158W	Red Oak
45	18	4	WCB358W	Red Oak
FINISHED END BASE				
18	4		WCEB18W	Red Oak
3/4 FINISHED END PANEL (required at exposed ends)				
18	72		WCEP1872W	Red Oak
FRONT CROWN MOLDING				
12	4		WCM12W	Red Oak
15	4		WCM15W	Red Oak
36	4		WCM36W	Red Oak
45	4		WCM45W	Red Oak
END CROWN MOLDING				
18	4		WCME18W	Red Oak





RECRUITER 2 WOOD SPORT LOCKERS

Get Your Team GAME READY!
Introducing our New Recruiter™
Set-Back QUICK-SHIP Design

Recruiter lockers are crafted of furniture grade red oak and finished using two coats of high grade cabinet lacquer. Red oak is naturally moisture and mildew resistant so you can be sure to benefit from your investment for years to come. Recruiter lockers are virtually unaffected by normal locker room conditions and are designed to stand up to daily use by today's athletes!

In addition to our standard stock designs and sizes, our engineers are readily available to assist you in custom designing a locker to meet your specific needs. Be it a fitness center, team locker room, country club or resort health spa, we stand behind our product with a full one year warranty that covers defects in materials and workmanship.



Stock Locker:
24"/30"W x 24"D x 84"H

Starter Unit Shown
Includes Two Finished
End Panels

GREAT STANDARD FEATURES

- Furniture Grade Red Oak Hardwood with Two Coats of Formaldehyde-Free Catalyzed Conversion Varnish for Excellent Moisture Resistance
- Modern Contour Edges with Wood Edge Banding
- Security Box with European Soft Close Hinges
- Three Lock Options Available
- Lower Foot Locker/Seat
- Stainless Steel Coat Rod
- Three Stainless Steel Hooks
- Starter/Adder Unit Configurations
- 24" x 24" x 84" and *30" x 24" x 84"
- Ships Fully-Assembled
- Includes Toe Kick Material
- 2 x 4 Sub-Base By Others

ADDITIONAL QUICK-SHIP ACCESSORIES
(ADDITIONAL LEAD-TIME APPLY)

- Logo UV Full Color Print Box Door, RLDOORLOGO
- End Filler 15", RLEF1584
- Corner Filler 15" x 15", RLCF151584

Starter units include (2) finished end panels to be used at row ends
Adder units do not include finished end panels
Order (1) Starter unit for each straight run of lockers and Adder units to fill out the run

OPTIONAL ADD ON ACCESSORIES



Seat Cushion (Black)
SC2424BK
SC3024BK



Name Plate Holder
NPH-0212S (12" wide)
NPH-0218S (18" wide)



Shoulder Pad Rack
SPHR14R



Shoulder Pad & Helmet Rack
SPHR18R



USB Outlet in Security Box
USB-4
USB-4-110

The beauty is in the details...

These lockers are high quality fine furniture. We take special pride in ensuring that each locker is a true work of art. All are made in our own manufacturing plant and shipped directly to you.

24" & *30" Wide Models Available From Quick-Ship



RECRUITER 2 WOOD SPORT LOCKERS



QUICK-SHIP LOCK OPTIONS



Standard Padlock
Cam Hasp



Built In
Combination Lock
Master Lock #1655



DigiTech-H1™
Electronic Lock

1 YEAR WARRANTY
STOCK COLOR

RED OAK

Width	Depth	Height	Starter Cat. No.	Adder Cat. No.
Recruiter 2 With Combination Lock Hasp				
24	24	84	R2SBS242484BNPLFSGRO-S	R2SBS242484BNPLFSGRO-A
Recruiter 2 With Built In Combination Lock				
24	24	84	R2SBS242484BNBCFSGRO-S	R2SBS242484BNBCFSGRO-A
Recruiter 2 With DigiTech™ H1 Electronic Lock				
24	24	84	R2SBS242484BNDTFSGRO-S	R2SBS242484BNDTFSGRO-A
End Filler Panels				
15	-	84	RLEF1584	
Corner Fillers				
24	24	84	RLCF242484	
36	36	84	RLCF363684	

SEE PAGE 122 FOR CUSTOM OPTIONS FROM PRODUCTION

Galvanite™ Rust Resistant Lockers

Galvanite lockers are fabricated from prime galvanized (hot-dipped zinc coated, annealed) sheet steel, then finished with an electrostatically applied high grade powder coat finish providing double protection against corrosion.

FEATURES:

BODY CONSTRUCTION: 24 gauge, galvanized corrosion resistant sheet steel

BODY STYLES: Single, double, triple and six tier

DOOR: 16 gauge, galvanized corrosion resistant sheet steel louvered for added ventilation, 18 gauge for box doors

HINGES: Continuous piano type

HANDLE (wardrobe): Stainless steel recessed handle with multi-point gravity lift-type latching. Recessed handle protects finish from being marred by padlock.

HANDLE (box): Box lockers include a projecting single-point friction catch door pull prepared for both padlock or built-in lock. No moving parts insures quiet maintenance-free operation.

HOOKS: One double prong ceiling hook and two single hooks per single and double tier opening. One double ceiling hook for triple tier. No hooks for six tier lockers.

COAT RODS: Available for single tier at a nominal cost

SHELVES: Hat shelf is included in single tier lockers.

LEGS: 6" high legs are standard. Lockers without legs are available for a nominal charge.



ANTIMICROBIAL PROTECTION



UPGRADED Antimicrobial Recessed Handle Finger Lift Cover & Box Door Finger Pulls

Lift covers and finger pulls are made of a super tough nylon material which includes an Antimicrobial agent offering protection against the growth of molds and bacteria.

GALVANITE™ RUST RESISTANT LOCKERS



Single Tier, 1 wide, 1 opening



Double Tier, 1 wide, 2 openings



Triple Tier, 3 wide, 9 openings



Six Tier, 3 wide, 18 openings

2 YEAR WARRANTY

PIANO HINGE STANDARD

IDEAL FOR HIGH HUMIDITY AND CORROSION PRONE AREAS



GALVANITE™ CORROSION RESISTANT SHEET STEEL PREVENTS RUST AND CORROSION

Galvanite™, is List Industries' trade marked name for lockers and cabinets manufactured with galvanized sheet steel components and finished with an electrostatically applied high-grade powder coat finish. Galvanneal and powder coat offer exceptional double protection against corrosion, even under the most adverse conditions. Tests indicate that galvanneal increases the estimated life-cycle threefold.



Galvanite™ cold rolled sheet steel with our powder coat finish after a 336 hour salt spray test.

Ideal for use in high humidity areas, outdoor locations, near shower or pool areas and food industry facilities.



WHAT IS GALVANNEAL?

Galvanneal is the result of the combined processes of galvanizing (hot-dipped zinc coating) and annealing (heat treatment). Galvanneal does not flake when formed or stamped. The very fine matte finish acts like a primer that easily adheres to paint.



Common cold rolled sheet steel after a 336 hour salt spray test.

Galvanite sheet steel can be ordered on any Production locker or cabinet as an option

These characteristics make galvanized sheet steel ideal for steel lockers in high humidity, corrosion prone areas.



Triple Tier, 1 wide, 3 openings

Width	Depth	Opening Height	Frame Height	Tier	Grouping	Openings Per Group	Knock-down Cat No.	Fully-Assembled Cat No.	Color Selection
SINGLE TIER									
12	12	72	78	1	1-wide	1	U1228-1G	U1228-1GA	PT
12	12	72	78	1	3-wide	3	U3228-1G	U3228-1GA	PT
12	15	72	78	1	1-wide	1	U1258-1G	U1258-1GA	PT
12	15	72	78	1	3-wide	3	U3258-1G	U3258-1GA	PT
12	18	72	78	1	1-wide	1	U1288-1G	U1288-1GA	PT
12	18	72	78	1	3-wide	3	U3288-1G	U3288-1GA	PT
DOUBLE TIER									
12	12	36	78	2	1-wide	2	U1228-2G	U1228-2GA	PT
12	12	36	78	2	3-wide	6	U3228-2G	U3228-2GA	PT
12	15	36	78	2	1-wide	2	U1258-2G	U1258-2GA	PT
12	15	36	78	2	3-wide	6	U3258-2G	U3258-2GA	PT
12	18	36	78	2	1-wide	2	U1288-2G	U1288-2GA	PT
12	18	36	78	2	3-wide	6	U3288-2G	U3288-2GA	PT
TRIPLE TIER									
12	12	24	78	3	1-wide	3	U1228-3G	U1228-3GA	PT
12	12	24	78	3	3-wide	9	U3228-3G	U3228-3GA	PT
12	15	24	78	3	1-wide	3	U1258-3G	U1258-3GA	PT
12	15	24	78	3	3-wide	9	U3258-3G	U3258-3GA	PT
12	18	24	78	3	1-wide	3	U1288-3G	U1288-3GA	PT
12	18	24	78	3	3-wide	9	U3288-3G	U3288-3GA	PT
SIX TIER									
12	12	12	78	6	1-wide	6	U1228-6G	U1228-6GA	PT
12	12	12	78	6	3-wide	18	U3228-6G	U3228-6GA	PT
12	15	12	78	6	1-wide	6	U1258-6G	U1258-6GA	PT
12	15	12	78	6	3-wide	18	U3258-6G	U3258-6GA	PT
12	18	12	78	6	1-wide	6	U1288-6G	U1288-6GA	PT
12	18	12	78	6	3-wide	18	U3288-6G	U3288-6GA	PT



729
TAN (PT)



LOCKER ACCESSORIES
PAGES 86-87

GALVANITE™ RUST RESISTANT LOCKERS



6-Tier,
1 wide,
6 openings

Z-Tier,
3 wide,
6 openings



Wardrobe Doors:
Projecting solid plastic handle with lift-type latching

Box Locker Doors:
Single-point thru-the-door projecting friction catch door pull with padlock hasp

AQUAMAX
HDPE PLASTIC LOCKERS

Aquamax Solid Plastic Lockers are Ideal for applications where high humidity, moisture and water are present. Plastic lockers are fabricated from solid high density polyethylene panels (HDPE) for maximum strength and durability while providing corrosion resistance to most common chemicals.

FEATURES:

BODY CONSTRUCTION: Corrosion Proof High Density Polyethylene (HDPE), with 3/8" thick body panels

BODY STYLES: Single, double, triple, six tier and z-tier

HINGES: heavy-duty continuous full height extruded aluminum with a powder-coat finish to match color of door

HANDLE (Wardrobe): Projecting solid plastic handle with lift-type latching

HANDLE (Box): Single-point thru-the-door padlock hasp with projecting door pull

SHELVES: Hat shelf is included in single tier lockers

HOOKS: 2 single-prong hooks in single and double tier lockers

ADVANTAGES:

- Scratch Resistant
- Corrosion Resistant
- Mildew and odor resistant
- Graffiti resistant
- Impact and dent resistant
- Easy to clean
- Chemical Resistant

20 YEAR WARRANTY

PIANO HINGE STANDARD

Width	Depth	Opening Height	Overall Height	Tier	Frame Grouping	Openings Per Group	Taupe Cat No.	Blue/Taupe Cat No.
SINGLE TIER								
12	18	72	72	1	1-wide	1	HPL1282-1A-TE	HPL1282-1A-TB
12	18	72	72	1	3-wide	3	HPL3282-1A-TE	HPL1382-1A-TB
DOUBLE TIER								
12	18	36	72	2	1-wide	2	HPL1282-2A-TE	HPL1282-2A-TB
12	18	36	72	2	3-wide	6	HPL3282-2A-TE	HPL3282-2A-TB
TRIPLE TIER								
12	18	24	72	3	1-wide	3	HPL1282-3A-TE	HPL1282-3A-TB
12	18	24	72	3	3-wide	9	HPL3282-3A-TE	HPL3282-3A-TB
SIX TIER								
12	18	12	72	6	1-wide	6	HPL1282-6A-TE	HPL1282-6A-TB
12	18	12	72	6	3-wide	18	HPL3282-6A-TE	HPL3282-6A-TB
Z-STYLE								
12	18	48	72	Z	1-wide	2	HPL1282-ZA-TE	HPL1282-ZA-TB
12	18	48	72	Z	3-wide	6	HPL3282-ZA-TE	HPL3282-ZA-TB

STOCK COLOR

TAUPE DOORS

TAUPE BODY

BLUE DOORS

TAUPE BODY

ANTIMICROBIAL & CORROSION RESISTANT PLASTIC LOCKERS



MedSafe AquaMax lockers are manufactured with high density polyethylene (HDPE) that contains a specially formulated ANTIMICROBIAL agent that permanently resists the growth of bacteria, mold, yeast and mildew. This special feature combined with all the great features of our AquaMax lockers make these lockers ideal for use in medical, educational, retail and manufacturing environments.

FEATURES:

BODY CONSTRUCTION: Corrosion Proof High Density Polyethylene (HDPE), with 3/8" thick body panels

BODY STYLES: Single, double, triple, six tier and z-tier

HINGES: heavy-duty continuous full height extruded aluminum with a powder-coat finish to match color of door

HANDLE (Wardrobe): Projecting solid plastic handle with lift-type latching

HANDLE (Box): Single-point thru-the-door projecting friction catch door pull with padlock hasp

SHELVES: Hat shelf is included in single tier lockers

HOOKS: 2 single-prong hooks in single and double tier lockers

ADVANTAGES:

- Permanent antimicrobial protection - kills microbes (yeast, bacteria, mold, mildew)
- Scratch Resistant
- Corrosion Resistant
- Impact and dent resistant
- Easy to clean
- Mildew and odor resistant
- Graffiti resistant
(pencil, pen, paint and most common markers)
- Chemical Resistant

20 YEAR WARRANTY

PIANO HINGE STANDARD



1-Tier,
3 wide,
3 openings



2-Tier,
3 wide,
6 openings



Z-Tier,
3 wide,
6 openings

Width	Depth	Opening Height	Overall Height	Frame Tier	Openings Grouping	Openings Per Group	Cat No.
SINGLE TIER							
12	18	72	72	1	1-wide	1	MSPL1282-1A-WE
12	18	72	72	1	3-wide	3	MSPL3282-1A-WE
DOUBLE TIER							
12	18	36	72	2	1-wide	2	MSPL1282-2A-WE
12	18	36	72	2	3-wide	6	MSPL3282-2A-WE
Z-STYLE							
12	18	48	72	Z	1-wide	2	MSPL1282-ZA-WE
12	18	48	72	Z	3-wide	6	MSPL3282-ZA-WE



White lockers with Taupe handles



MEDSAFE™ AQUAMAX™ LOCKERS

VERSAMAX™
SOLID PHENOLIC LOCKERS

VersaMax Phenolic Lockers are the most durable lockers available. The unique non-porous surface of phenolic material eliminates the ability for mold, mildew and bacteria to grow making these lockers ideal for wet or damp areas. In addition to this primary benefit, the surface of VersaMax Phenolic Lockers are also water proof and graffiti and scratch resistant.

20 YEAR WARRANTY



Six-Tier
1 wide

Two-Tier
1 wide

Z-Style
1 wide

FEATURES:

BODY CONSTRUCTION: Phenolic construction, Sides and backs are 5/16" thick. Tops, bottoms and shelves are 3/8" thick.

BODY STYLES: Single tier, double tier, six tier and z-tier

DOORS: 1/2" thick solid phenolic with perimeter ventilation

HINGES: 5-knuckle "hospital" type 14 gauge 304 stainless steel, black powder coat finish, exposed, doors open 180°

HANDLE (Padlock Ready): 11 gauge finger-pull 304 stainless steel hasp, prepared for padlock

HANDLE (Electronic Lock): Built-in DigiTech H1 Lock serves as handle

HANDLE (Key Cam Lock): Built-in key cam lock serves as handle

SHELVES: Hat shelf is included in single tier lockers

HOOKS: 2 single-prong hooks in single and double tier lockers

COLOR: Figured Annigre

WARRANTY: 20 years

ADVANTAGES:

- Phenolic's unique non-porous surface eliminates the ability for mold, bacteria and mildew to grow making it ideal for wet areas.
- Corrosion Resistant
- Impact and dent resistant
- Easy to clean
- Fungus and odor resistant
- Graffiti resistant (pencil, pen, paint and most common markers)

AVAILABLE FROM STOCK WITH 3 DIFFERENT LOCK CHOICES:

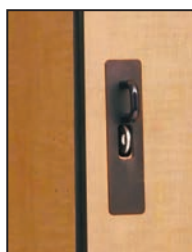

Padlock Hasp



DigiTech™ H1
Electronic Locks



Built-In Key Cam
Locks



7284-58
FIGURED ANNIGRE

Width	Depth	Opening Height	Overall Height	Tier	Frame Grouping	Openings Per Group	(Padlocks sold separately) Cat No.	With DigiTech™ Electronic Access Locks Cat No.	With Key Cam Lock Cat No.
SINGLE TIER									
12	18	72	72	1	1-wide	1	PHL1282-1A-FA	PHL1282-1A-E-FA	PHL1282-1A-K-FA
12	18	72	72	1	3-wide	3	PHL3282-1A-FA	PHL3282-1A-E-FA	PHL3282-1A-K-FA
DOUBLE TIER									
12	18	36	72	2	1-wide	2	PHL1282-2A-FA	PHL1282-2A-E-FA	PHL1282-2A-K-FA
12	18	36	72	2	3-wide	6	PHL3282-2A-FA	PHL3282-2A-E-FA	PHL3282-2A-K-FA
SIX TIER									
12	18	12	72	6	1-wide	6	PHL1282-6A-FA	PHL1282-6A-E-FA	PHL1282-6A-K-FA
12	18	12	72	6	3-wide	18	PHL3282-6A-FA	PHL3282-6A-E-FA	PHL3282-6A-K-FA
Z-STYLE									
12	18	42	72	Z	1-wide	2	PHL1282-ZA-FA	PHL1282-ZA-E-FA	PHL1282-ZA-K-FA
12	18	42	72	Z	3-wide	6	PHL3282-ZA-FA	PHL3282-ZA-E-FA	PHL3282-ZA-K-FA

ATTRACTIVE DURABLE
CORROSION RESISTANT



Hallowell
Hallowell-List.com

304 Stainless Steel



Single-Tier,
1 wide,
1 opening

Double-Tier,
3 wide,
6 openings

Six-Tier,
1 wide,
6 openings

The rich appearance and durable surface of Hallowell 304 Stainless Steel Lockers make them the perfect locker solution for areas prone to rust and sanitation concerns and are ideal for food industry, pool area and outdoor.

FEATURES:

BODY CONSTRUCTION: knock-down 24 gauge

BODY STYLES: Single, double, and six tier

DOORS: Louvered. 16 gauge for single and double tier lockers. 18 gauge for 6-tier box lockers

LATCHING: Single and double tier use gravity-lift and six-tier uses single-point, through the door finger pull

HINGES: 2-1/2" 5-knuckle hinges. 3 hinges for single tier and 2 hinges for double & six tier

HANDLE: Single and double tier lockers have a deep drawn stainless steel recessed handle with multi-point gravity lift-type latching. Six tier lockers have a finger pull handle

COAT RODS: Available for single tier at a nominal cost

SHELVES: Hat shelf is included in single tier lockers

HOOKS: One double prong ceiling hook and three single hooks per single and double tier opening. No hooks for six tier

COLOR: Stainless steel

WARRANTY: 2 years

2 YEAR WARRANTY

Width	Depth	Opening Height	Overall Height	Tier	Frame Grouping	Openings Per Group	Knock-Down Cat No.	Fully-Assembled Cat No.
SINGLE TIER								
12	18	72	78	1	1-wide	1	USS1288-1	USS1288-1A
12	18	72	78	1	3-wide	3	USS3288-1	USS3288-1A
18	18	72	78	1	1-wide	1	USS1888-1	USS1888-1A
18	18	72	78	1	3-wide	3	USS3888-1	USS3888-1A
DOUBLE TIER								
12	18	36	78	2	1-wide	2	USS1288-2	USS1288-2A
12	18	36	78	2	3-wide	6	USS3288-2	USS3288-2A
18	18	36	78	2	1-wide	2	USS1888-2	USS1888-2A
18	18	36	78	2	3-wide	6	USS3888-2	USS3888-2A
SIX TIER								
12	18	12	78	6	1-wide	6	USS1288-6	USS1288-6A
12	18	12	78	6	3-wide	18	USS3288-6	USS3288-6A
18	18	12	78	6	1-wide	6	USS1888-6	USS1888-6A
18	18	12	78	6	3-wide	18	USS3888-6	USS3888-6A

	Width	Depth	Height	Cat No.
ACCESSORIES				
Individual Slope Top	12	18	6	KISTT1218SS
	12	18	6	KISTT1818SS
Slope Top End Closure	-	18	6	KISE18SS
Closed Front Base	12	-	6	KCFB12SS
	18	-	6	KCFB18SS
Closed Side Base	-	18	6	KCSB18SS
Coat Rod Assembly	12	-	-	KCR12SS
	18	-	-	KCR18SS

ANTIMICROBIAL PROTECTION



UPGRADED Antimicrobial Recessed Handle Finger Lift Cover & Box Door Finger Pulls

Lift covers and finger pulls are made of a super tough nylon material which includes an Antimicrobial agent offering protection against the growth of molds and bacteria.

STOCK COLOR

STAINLESS STEEL

LOCKER ACCESSORIES PAGES 86-87

304 STAINLESS STEEL LOCKERS

5 DAY SHIPPING ON ALL IN-STOCK PRODUCTS

KID LOCKERS

7 Bright Kid Friendly Colors!!!

GREAT for:

- ✓ **Kid's Bedrooms**
- ✓ **Garages**
- ✓ **Playroom lockers**
- ✓ **Mudroom lockers**



FEATURES:

BODY CONSTRUCTION: knock-down (KD) 24 gauge solid body components, 20 gauge top

BODY STYLES: Teen, Kid

FRAME: 16 gauge frame

SHELVES: Teen Locker has 1 fixed hat shelf, Kid locker has no shelves

HOOKS: Teen locker shall include one double hook and two single hooks attached to hat shelf. No hooks for Kid Locker

HINGES: 16 gauge continuous piano hinge

DOORS: 16 gauge louvered doors

LATCHING: Gravity lift type latching

HANDLE: Recessed stainless steel

COLOR: 7 bright kid-friendly colors



UPGRADED Antimicrobial Recessed Handle Finger Lift Cover

All gravity lift-type latching lockers that include recessed handles include our Antimicrobial Recessed Handle Finger Lift Cover for protection against the growth of molds and bacteria

2 YEAR WARRANTY

PIANO HINGE STANDARD

Width	Depth	Opening Height	Frame Height	Tier	Grouping	Openings Per Group	Knock-Down Cat No.	Color Selection
KID LOCKER								
15	15	24	24	1	1-wide	1	HKL1515(24)-1	BG, GS, HP, PR, RR, SA, TY
TEEN LOCKER								
15	15	48	48	1	1-wide	1	HKL151548-1	BG, GS, HP, PR, RR, SA, TY



STOCK COLOR SELECTION

- 720
PEP RALLY (PR)
- 721
RELAY RED (RR)
- 739
BUBBLE GUM (BG)
- 1134
SOUR APPLE (SA)
- 717
GRAND SLAM (GS)
- 728
HOOP (HP)
- 723
TROPHY (TY)

SHOW YOUR
TEAM SPIRIT



Hallowell
Hallowell-List.com

HOME TEAM LOCKERS

SHOW YOUR
TEAM COLORS

IDEAL FOR HOME USE!

5 color combinations & 3 New solid colors

Home Team Lockers are 48 inch high wardrobe lockers with fixed upper hat shelf and hooks. All lockers are standard with diamond perforated doors and without legs



NEW SOLID
COLORS



HOME TEAM LOCKERS

FEATURES:

- BODY CONSTRUCTION:** knock-down (KD) 24 gauge body 20 gauge top
- FRAME:** 16 gauge frame
- SHELVES:** 1 fixed hat shelf
- HOOKS:** Home Team locker includes one double hook and two single hooks

- HINGES:** 16 gauge continuous piano hinge
- DOORS:** 16 gauge louvered doors
- LATCHING:** Gravity lift type latching
- HANDLE:** Recessed stainless steel

**PIANO HINGE
STANDARD**

**2 YEAR
WARRANTY**



UPGRADED Antimicrobial Recessed Handle Finger Lift Cover

All gravity lift-type latching lockers that include recessed handles include our Antimicrobial Recessed Handle Finger Lift Cover for protection against the growth of molds and bacteria

Width	Depth	Opening Height	Frame Height	Tier	Grouping	Openings Per Group	Knock-Down Cat No.	Color Selection
HOME TEAM LOCKER								
15	15	48	48	1	1-wide	1	HTL151548-1	JH, MT, GR, RS, JP, GS, BG, RR



STOCK COLOR SELECTION

JH DARK BLUE Body/Frame ORANGE Door	MT BLACK Body/Frame YELLOW Door	GR BLUE Body/Frame RED Door	RS RED Body/Frame WHITE Door	JP DARK BLUE Body/Frame LIGHT GRAY Door	GS 717 GRAND SLAM	BG 739 BUBBLE GUM	RR 721 RELAY RED
--	--	--	---	--	-----------------------------	-----------------------------	----------------------------

5 DAY SHIPPING ON ALL IN-STOCK PRODUCTS

101

CUBIX

Stack Cubix lockers and easily attach adjacent units with pre-punched holes on top, sides and bottom. Or use the keyhole punched back for wall mounting.

- **THREE DOOR STYLES**
- **THREE DOOR COLORS**
- **TWO LOCK OPTIONS**



Ventilated Diamond Perforated Door
Padlock Hasp
Light Gray



Safety-View™ Door
Key Lock
Marine Blue



Plain Locker Door
Key Lock
Black

CUBIX MODULAR BOX LOCKERS



Wall Mounting



Above or Below a Workbench



Desk Mounting



Closet Mounting

FEATURES:

BODY CONSTRUCTION: Knock-down, 16 gauge

HINGES: 16 gauge continuous piano hinge

DOORS: 18 gauge Solid (non-vented), Diamond Perforated, or Safety-View (clear)

HANDLE/LOCKS: Finger pull latch prepared for padlock (sold separately), or Built-in key lock

COLOR: Marine Blue, Black, Light Gray

WARRANTY: 2 years



UPGRADED Antimicrobial Box Door Finger Pulls

All box door finger pulls are made of a super tough nylon material which includes an Antimicrobial agent offering protection against the growth of molds and bacteria.

Description	Overall Width	Overall Height	Overall Depth	Catalog No.	Color Selection
PREPARED FOR PADLOCK (not included)					
Ventilated Door	11-5/16	12-11/16	12	HC121212-1DP	MB, ME, PL
Solid Door	11-5/16	12-11/16	12	HC121212-1PL	MB, ME, PL
Safety-View Plus Door	11-5/16	12-11/16	12	HC121212-1SVP	MB, ME, PL
WITH BUILT-IN KEY LOCK (included)					
Ventilated Door	11-5/16	12-11/16	12	HC121212-1DP-K	MB, ME, PL
Solid Door	11-5/16	12-11/16	12	HC121212-1PL-K	MB, ME, PL
Safety-View Plus Door	11-5/16	12-11/16	12	HC121212-1SVP-K	MB, ME, PL

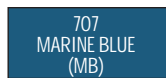
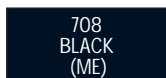



Ideal for use in government buildings, schools, health clubs or any location where personal items, cell phones and tablets need to be securely stored.

FEATURES:

BODY CONSTRUCTION: 20 gauge cold rolled steel

HINGES: 16 gauge continuous piano hinge

DOORS: 20 gauge solid (non-vented)

HANDLE/LOCKS: Locks serve as door handle/pull

PADLOCK: hasp cam lock for padlocks by others

KEY LOCK: Cylinder cam locks control keyed to one system

DIGITECH LOCK: Electronic access lock in temporary-use mode that can be programmed for permanent use

COLOR: Light Gray

WARRANTY: 2 year



Shown With Digitech Electronic Access Lock

EASILY STORE AND PROTECT PERSONAL BELONGINGS.

CHOOSE FROM 3 DIFFERENT LOCK OPTIONS.



PREPARED FOR PADLOCK



DIGITECH ELECTRONIC ACCESS LOCK



KEY CAM LOCK

Overall Width	Height	Depth	Grouping	Openings Per Group	Padlock Ready (Padlocks sold separately) Cat No.	With DigiTech™ Electronic Access Locks Cat No.	With Key Cam Lock Cat No.	Color Selection
MOBILE DEVICE LOCKERS								
9	30 1/2	12	1-wide	5	UCTL192(30)-5A	UCTL192(30)-5A-E	UCTL192(30)-5A-K	PL
27	30 1/2	12	3-wide	15	UCTL392(30)-5A	UCTL392(30)-5A-E	UCTL392(30)-5A-K	PL

Clear Opening Width	Clear Opening Height	Clear Opening Depth
Mobile Device Lockers		
7 1/2	5 1/2	11



CELL PHONE / TABLET LOCKERS



BACKPACK / LAPTOP LOCKERS

- ✓ **Electronic access door keeps items secure**
- ✓ **One shelf per opening**
- ✓ **Prepared for after market wiring to allow charging**
- ✓ **Side ventilation allows maximum airflow for cooling while maintaining security**
- ✓ **711 Light Gray powder coat finish**



Built-in Hallowell Electronic Access Digitech lock - also acts as locker handle

DIGITECH™ LAPTOP / BACKPACK LOCKERS



**4-TIER
3-WIDE
12 OPENINGS**



**3-TIER
3-WIDE
9 OPENINGS**



**4-TIER
1-WIDE
4 OPENINGS**



**3-TIER
1-WIDE
3 OPENINGS**



WIRE CHASE

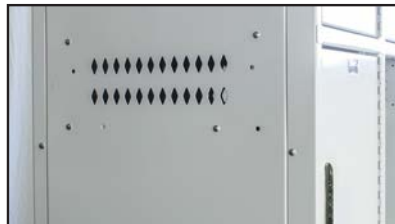

ELECTRICAL KNOCK-OUT



POWERED

Each locker has built-in channel for concealed after-market wiring to convert lockers to charging stations.

VENTILATED

Diamond perforations in locker sides promote continuous air flow to cool chargers and components while keeping your items secure.

EASILY CONVERTS TO CHARGING LOCKERS



LOCK FEATURES:

- Powered by 1 CR123 battery which provide in excess of 10,000 uses.
- 1 CR123 battery is included.
- LED's flash to indicate low battery level.
- Locker can be opened when batteries are low or dead by using the Master Key override.
- 8-digit master and sub-master codes for two levels of management security.

DAY-USE MODE:

- User can lock and unlock any available locker door with a user selected 4-digit code.
- Upon returning, user enters the 4-digit code to unlock the door. Code is erased and the locker is available for the next user.

PERMANENT MODE:

- User enters a pre-programmed 4-digit code to unlock and use locker repeatedly.
- Lock does not require a code to re-lock door.

FEATURES:

BODY CONSTRUCTION: 16 gauge sheet steel with sides diamond perforated

BODY STYLES: 3-tier, 4-tier

FRAME: 16 gauge welded frame

DOORS: 14 gauge solid sheet steel

HINGES: 16 gauge continuous piano hinge

HANDLE: Hallowell DigiTech™ electronic, code access lock serves as handle

SHELVES: 1 fixed hat shelf

HOOKS: none

COLOR: 711 Light Gray

WARRANTY: 2 years

Digitech Electronic Access Lock



SPECIAL FEATURES:

- Each locker has built-in channel for concealing after-market wiring to convert lockers to charging stations.
- Channel shall include knock-outs for electrical outlet in each opening.

DIGITECH™ LAPTOP / BACKPACK LOCKERS

Width	Depth	Height	Grouping	Openings Per Group	Unassembled Cat No.	Assembled Cat No.	Color Selection
TRIPLE TIER							
15	18	78	1-wide	3	UELBP1588-3	UELBP1588-3A-PL	PL
45	18	78	3-wide	9	UELBP3588-3	UELBP3588-3A-PL	PL
15	21	78	1-wide	3	UELBP1518-3	UELBP1518-3A-PL	PL
45	21	78	3-wide	9	UELBP3518-3	UELBP3518-3A-PL	PL
18	18	78	1-wide	3	UELBP1888-3	UELBP1888-3A-PL	PL
54	18	78	3-wide	9	UELBP3888-3	UELBP3888-3A-PL	PL
18	21	78	1-wide	3	UELBP1818-3	UELBP1818-3A-PL	PL
54	21	78	3-wide	9	UELBP3818-3	UELBP3818-3A-PL	PL
FOUR TIER							
15	18	78	1-wide	4	UELBP1588-4PL	UELBP1588-4A-PL	PL
45	18	78	3-wide	12	UELBP3588-4PL	UELBP3588-4A-PL	PL
15	21	78	1-wide	4	UELBP1518-4PL	UELBP1518-4A-PL	PL
45	21	78	3-wide	12	UELBP3518-4PL	UELBP3518-4A-PL	PL
18	18	78	1-wide	4	UELBP1888-4PL	UELBP1888-4A-PL	PL
54	18	78	3-wide	12	UELBP3888-4PL	UELBP3888-4A-PL	PL
18	21	78	1-wide	4	UELBP1818-4PL	UELBP1818-4A-PL	PL
54	21	78	3-wide	12	UELBP3818-4PL	UELBP3818-4A-PL	PL

**PIANO HINGE
STANDARD**

**2 YEAR
WARRANTY**

**STOCK
COLOR**

711
LIGHT GRAY
(PL)

Turnout Gear/Firefighter Lockers

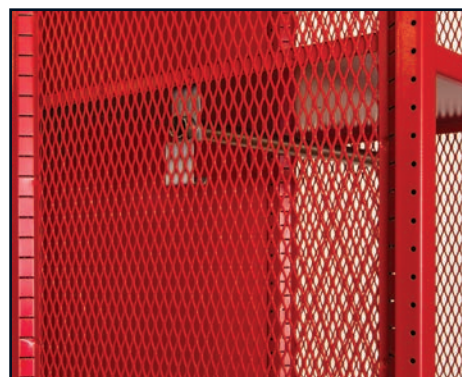

EXPANDED METAL SIDES FOR
MAXIMUM VENTILATION

FEATURES:

BODY CONSTRUCTION: 13 gauge 1/2" flattened expanded metal

FRAME: 16 gauge Hollow "T" tubular frame

DOOR (Security Box): 14 gauge cold rolled sheet-steel

HINGES (Security Box): Two heavy-duty 13 gauge 7-knuckle 3-1/2"

HANDLE (Security Box): Projecting combination spring-bolt/padlock hasp door pull

SHELVES: One Galvanneal hat/intermediate shelf and 1 fixed hat shelf.

HOOKS: Two single prong hooks at back and two hooks at coat rod ends.

WARRANTY: Lifetime

**FULLY-FRAMED
ALL-WELDED**

**LIFE TIME
WARRANTY**

**ANTIMICROBIAL
PROTECTION**

**UPGRADED Antimicrobial
Box Door Finger Pulls**



All box door finger pulls are made of a super tough nylon material which includes an Antimicrobial agent offering protection against the growth of molds and bacteria.

Choose from 4 Models



Base Model
Without Base



Base Model
With Base



With Upper
Security Box
Without Base



With Upper
Security Box
With Base

DESIGNED FOR TODAY'S FIREFIGHTER



Hallowell
Hallowell-List.com

- ✓ Fully-framed, all welded, rugged construction.
- ✓ Maximum ventilation with expanded metal sides.
- ✓ Upper shelf provides storage for helmets and head gear.
- ✓ Without base models include ventilated bottom.
- ✓ Open-front provides quick access to gear and clothing.
- ✓ 721 Relay Red hammertone textured powder coat finish.



TURN OUT GEAR LOCKERS



OPTIONAL SECURITY BOX USES TWO HEAVY-DUTY 13 GAUGE 7-KNUCKLE 3-1/2" HINGES AND A FINGER PULL PADLOCK HASP



FIXED HAT SHELF AND STAINLESS STEEL COAT-ROD WITH 2 SINGLE PRONG HOOKS



MODELS WITHOUT BASE HAVE VENTILATED BOTTOM PLATE AND ARE DESIGNED TO BE INSTALLED ON THE WALL WITH THE WALL MOUNTING ANGLE



MODELS WITH BASE ARE DESIGNED TO BE INSTALLED ON THE FLOOR

Description	Width	Depth	Height	Assembled Cat No.	Color Selection
BASE MODEL					
Without Base	24-3/4	22	84	TGNN42(84)-1C-G	RR-HT
With Base	24-3/4	22	86-1/4	TGNN42(84)-1BC-G	RR-HT
WITH UPPER SECURITY BOX					
Without Base	24-3/4	22	84	TGBN42(84)-1C-G	RR-HT
With Base	24-3/4	22	86-1/4	TGBN42(84)-1BC-G	RR-HT
WALL MOUNTING ANGLE FOR MODELS WITHOUT BASE					
	72	3	3	TGWMA030372	RR-HT



521
RELAY RED HAMMERTONE
(RR-HT)

5 DAY SHIPPING ON ALL IN-STOCK PRODUCTS

Five distinct models to choose, Specifically designed for the uniform use industry.



UNIFORM Exchange Lockers™

The Industry Standard in the Uniform Distribution System.

UNIFORM EXCHANGE LOCKERS



9 Person Uniform Exchange Locker Model HUE454-9P



8 Person Uniform Exchange Locker Model HUE214-8P



1 YEAR WARRANTY

UNIFORM DISTRIBUTION SYSTEM



Hallowell
Hallowell-List.com



Half Height Hanging Uniform Locker Model HUE214-2

FEATURES:

- ✓ Master door with H-1 industry standard lock and key
- ✓ Padlock attachment (padlock not included)
- ✓ Ships fully assembled
- ✓ Perforated backs for ample ventilation
- ✓ Galvanized locker bottoms with return flanges
- ✓ Color selection: Dark Gray
- ✓ Full 1 year warranty



Full Height Hanging Uniform Locker Model HUE214-1



Soiled Uniform Exchange Locker Model HUE614-1



User doors re-inforced at latches

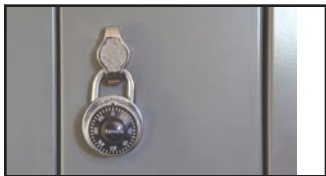

Heavy-duty padlock handles (locks not included)



Main door latch hooks welded to frame

STOCK COLOR
725
DARK GRAY (HG)

Width	Depth	Opening Height	Frame Height	Tier	Grouping	Openings Per Group	Fully-Assembled Cat. No.	Color Selection
8 PERSON UNIFORM EXCHANGE LOCKER								
32 9/16	21	38 3/4	84	8	1-wide	8	HUE214-8P	HG
9 PERSON UNIFORM EXCHANGE LOCKER								
24	15	8 3/4	84	9	1-wide	9	HUE454-9P	HG
SOILED UNIFORM EXCHANGE LOCKER								
26	21	70 3/4	84	1	1-wide	1	HUE614-SC	HG
HALF OR FILL HEIGHT HANGING UNIFORM LOCKER								
32 9/16	21	81	84	1	1-wide	1	HUE214-1	HG
32 9/16	21	40	84	1	1-wide	2	HUE214-2	HG

UNIFORM EXCHANGE LOCKERS

5 DAY SHIPPING ON ALL IN-STOCK PRODUCTS

109

ALL-WELDED LOCKERS

MAXVIEW

**FULLY-FRAMED
ALL-WELDED**

**LIFE TIME
WARRANTY**



Hallowell All-Welded MaxView lockers are perfect for tool, equipment and gear storage.

FEATURES:

BODY CONSTRUCTION: All-welded 16 gauge heavy-duty tubular frame construction from galvanized sheet steel, sides and back are 1/2" 13 gauge flattened expanded metal. Top and bottom are heavy-duty galvanized corrosion resistant sheet steel, fully-assembled

BODY STYLES: Single tier

DOOR: 14 gauge door is diamond perforated for maximum visibility and ventilation. Includes a welded-in full height door stiffener

HINGES: Heavy-duty 13 gauge 7-knuckle (3 hinges per door)

HANDLE: Single-point projecting friction catch door pull prepared for both padlock or built-in lock.

SHELVES: Four 16 gauge sheet steel welded-in fixed shelves are fabricated from galvanized corrosion resistant sheet steel add additional rigidity to the unit.

- All-welded heavy-duty construction
- 4 sided viewing of locker contents
- 4 sided ventilation
- Corrosion resistant
- Lifetime warranty
- Full height 3-1/2" wide door stiffener



ANTIMICROBIAL PROTECTION

UPGRADED Antimicrobial Finger Pulls

Door finger pull is made of a super tough nylon material which includes an Antimicrobial agent offering protection against the growth of molds and bacteria.

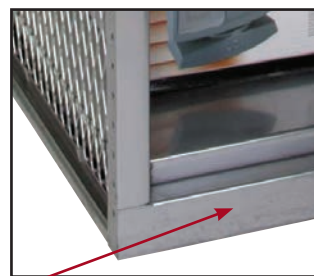

Heavy gauge tubular frame. Bottom shelf of locker sits a full 2-3/4" above finished floor protecting locker contents from water damage.

**STOCK
COLOR**

711
LIGHT GRAY
(PL)

Width	Depth	Opening Height	Frame Height	Tier	Grouping	Openings Per Group	Fully-Assembled Cat No.	Color Selection
SINGLE TIER								
18-3/4	18	72	74-3/4	1	1-wide	1	HLV882-1PL	PL

MAXVIEW™ CORROSION RESISTANT LOCKERS

THE INDUSTRY'S
TOUGHEST LOCKER



Hallowell
Hallowell-List.com

SINGLE POINT

-  **FULLY-FRAMED ALL-WELDED**
-  **LIFE TIME WARRANTY**

Welded Single-Point Ventilated Lockers

FEATURES:

BODY CONSTRUCTION: All-welded, fully-assembled

BODY STYLES: Single and double tier custom

FEATURES: 16 gauge continuous top for added rigidity, 11 gauge MIG welded latch, continuous door strike at hinge and latch side

DOOR: 14 gauge door is diamond perforated for added visibility and ventilation and includes a welded-in full height door stiffener

HINGES: Continuous piano type

HANDLE: Deep-drawn seamless stainless steel recessed handle with single-point thru-the-handle maintenance-free quiet latching system

SHELVES: Hat shelf for single tier

Lockers include a 3" wide 18 gauge full height door stiffener spot welded to the inner door face and MIG welded to the hinge side as well as to the top and bottom door flanges providing a rigid torque-free door.

Single-point maintenance-free quiet latching system with recessed handle



Single Tier,
3 wide,
3 openings



Double Tier,
3 wide,
6 openings



Single Tier,
1 wide,
1 opening

Width	Depth	Opening Height	Frame Height	Tier	Grouping	Openings Per Group	Fully-Assembled Cat No.	Color Selection
SINGLE TIER								
12	12	72	72	1	1-wide	1	HWBA212-1	HG
12	12	72	72	1	3-wide	3	HWBA212-111	HG
12	18	72	72	1	1-wide	1	HWBA282-1	HG
12	18	72	72	1	3-wide	3	HWBA282-111	HG
18	18	72	72	1	1-wide	1	HWBA882-1	HG
18	18	72	72	1	3-wide	3	HWBA882-111	HG
DOUBLE TIER								
12	12	36	72	2	1-wide	2	HWBA212-2	HG
12	12	36	72	2	3-wide	6	HWBA212-222	HG
12	18	36	72	2	1-wide	2	HWBA282-2	HG
12	18	36	72	2	3-wide	6	HWBA282-222	HG
18	18	36	72	2	1-wide	2	HWBA882-2	HG
18	18	36	72	2	3-wide	6	HWBA882-222	HG



725
DARK GRAY (HG)

SINGLE-POINT VENTILATED LOCKERS

5 DAY SHIPPING ON ALL IN-STOCK PRODUCTS

111



Perfect For Swat, Police, Fire & Emergency Response Teams

TASK FORCE XP PERFORMANCE LOCKERS

FEATURES:

BODY CONSTRUCTION: 16 gauge, Unibody all-welded, galvanized corrosion resistant sheet steel. Back is 18 gauge

BODY STYLES: Single tier, custom designed for specialized use

DOOR: 14 gauge louvered double doors with full-height welded in stiffener

HINGES: Continuous piano type

HANDLE: 3-point high-security turn handle latching handle

HOOKS: Two single wall hooks in wardrobe area, single hook in opening below security box, single hook on door.

COAT RODS: One at vertical wardrobe section

SHELVES: Two full-width at top, one partial shelf above security box

LOCKS: Includes built in key lock for main and security box

SIZE: Wardrobe locker 24" x 24" x 72"

OPTIONAL: Base/drawer unit 24" x 36" x 18"



Standard electrical knockout at locker top right rear corner

- ✓ Utility belt hook
- ✓ Security box
- ✓ One side pocket shelf for a 1" thick clipboard
- ✓ Full height piano hinge
- ✓ Finish is standard Powder-coat
- ✓ Full height door stiffeners
- ✓ Lower storage area with pull-out drawer
- ✓ Auto-Locking drawer is activated by upper doors
- ✓ Electrical Knockout in locker top - outlet and wiring by others

STANDARD UPPER UNIT SIZES

Widths: 24", 30", 36"
 Depths: 18", 24"
 Height: 72"

STANDARD BASE UNIT SIZES

Widths: 24", 30", 36"
 Depths: 30" 36"
 Height: 18"

OPTIONS

- PEGBOARD DOOR STIFFENER
- BOOT TRAY
- BODY ARMOR DRYING RACK
- PERSONAL ITEMS ACCESSORY TRAY
- LOUVERED DRAWER FRONT
- PERFORATED TOP
- AIRFLOW GAP SHELVES SPACED AWAY FROM BACK FOR ADDED AIRFLOW

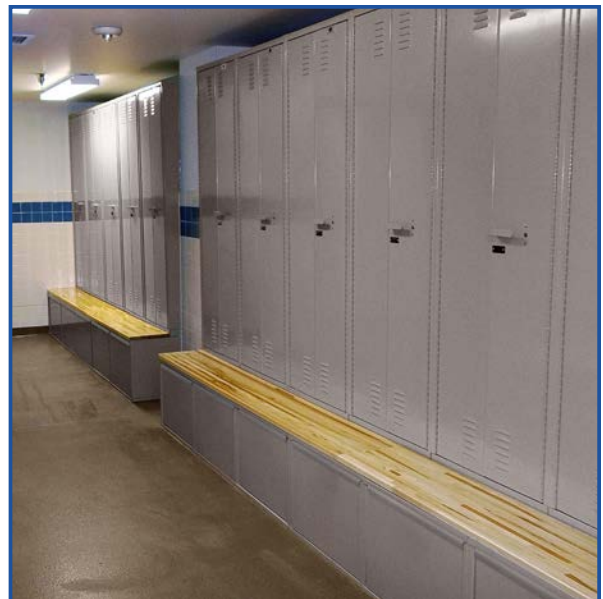

ENGINEERED TO LAST A LIFETIME



Hallowell

Hallowell-List.com



Large lockable storage compartment doubles as a seat finished in laminated maple wood.



Available with and without base storage compartment and seat

TASK FORCE XP PERFORMANCE LOCKERS



	Width	Depth	Opening Height	Unit Height	Tier	Grouping	Openings Per Group	Fully-Assembled Cat No.	Color Selection
SINGLE TIER									
Without base	24	24	72	72	1	1-wide	1	HERL442-1SL-G	HG
With base	24	24/36	72	90	1	1-wide	1	HERL442-1SL-B-G	HG



725 DARK GRAY (HG)

WELDED OPEN-FRONT SPORT LOCKERS

Choose from 4 models
SHIPS FULLY ASSEMBLED.



Base Model



With Upper Security Box



With Lower Foot Locker

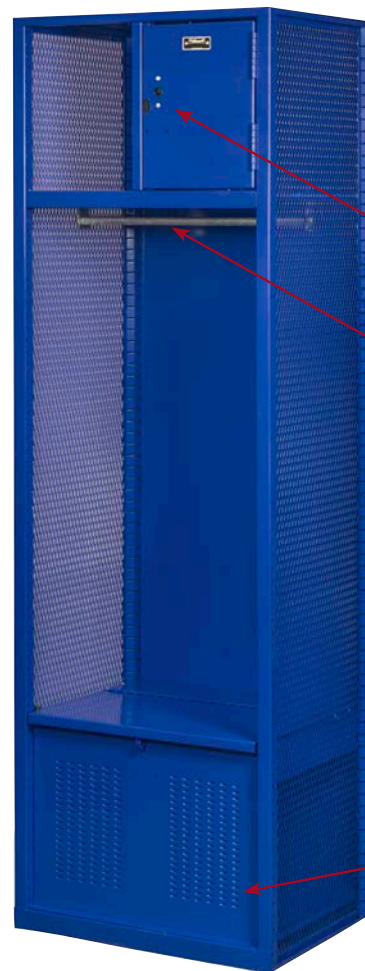

With Upper Security Box
And Foot Locker

SECURITY-BOX

STEEL COAT ROD

VENTILATED
FOOT LOCKER

FEATURES:

BODY COMPONENTS: 16 ga. tubular vertical frame members, 16 gauge body with 18 gauge back

TOP/BOTTOM/HAT SHELF 16 ga. solid cold rolled sheet steel

OPTIONS

SECURITY BOX DOOR: 14 gauge steel with a thru-the-door friction catch door pull, padlock hasp and a 16 gauge continuous piano hinge

FOOT LOCKER: 14 gauge steel with stiffener sections and padlock loop.

ANTIMICROBIAL PROTECTION



UPGRADED Antimicrobial Box Door Finger Pulls

All box door finger pulls are made of a super tough nylon material which includes an Antimicrobial agent offering protection against the growth of molds and bacteria.

BASE: 14 ga. Channel Base at both front and back

SIDES: 13 ga. 1/2" flattened expanded metal fully-framed on all four sides

ACCESSORIES: Includes 1/2" diameter coat rod, and 2 Coat hooks

Width	Depth	Height	Grouping	Catalog #
BASE MODEL				
24"	18"	74-3/4"	1-wide	WSNN482-1C
24"	24"	74-3/4"	1-wide	WSNN422-1C
WITH OPTIONAL UPPER SECURITY BOX				
24"	18"	74-3/4"	1-wide	WSBN482-1C
24"	24"	74-3/4"	1-wide	WSBN422-1C
WITH OPTIONAL LOWER FOOT LOCKER				
24"	18"	74-3/4"	1-wide	WSNF482-1C
24"	24"	74-3/4"	1-wide	WSNF422-1C
WITH OPTIONAL SECURITY BOX AND FOOT LOCKER				
24"	18"	74-3/4"	1-wide	WSBF482-1C
24"	24"	74-3/4"	1-wide	WSBF422-1C



721
RELAY RED (RR)

717
GRAND SLAM (GS)





Rough, Tough and Ready to Go!

**MILITARY SPEC TA-50
FULLY-FRAMED ALL-WELDED LOCKERS**

Manufactured with top quality steel and built to strict specifications, our TA-50 Military Grade Locker is the solution to all your storage challenges. Secure, durable and guaranteed to last a lifetime.



Rugged 3/16" Steel Handle is prepared for use with a padlock. Doors are pre-punched to accommodate a built-in combination or key lock if desired. Locks are available at an additional cost

TA-50 MILITARY GEAR LOCKERS



FEATURES:

BODY CONSTRUCTION: Fully-framed all-welded construction with 3/4" flattened expanded metal sides, 16 gauge solid top & bottom and 18 gauge solid back. Base is heavy 14 gauge on all four sides. High grade custom blend powder coat finish.

DOORS: Heavy-duty 14 gauge diamond perforated doors are standard.

DOOR HINGES: Heavy-duty 13 gauge 7-knuckle 3-1/2" butt hinges.

HANDLE: 3-point turn-handle latching with 3/8" diameter locking rods for maximum security.

SHELF: 16 gauge solid upper shelf.

EQUIPPED: 1 Coat rod and 3 rear hooks are located under upper shelf.



725
DARK GRAY (HG)



Width	Depth	Opening Height	Frame Height	Grouping	Openings Per Group	Fully-Assembled Cat No.	Color Selection
42	24	84	84	1-wide	1	TA50-422484-1	HG

SECURITY MAX™

Hallowell SecurityMax heavy-duty all-welded lockers offer the highest available security by incorporating an extra heavy-duty three point turn-handle locking mechanism and the versatility of adjustable interior shelves. Available in ventilated and solid locker versions.

SecurityMax lockers are ideal where heavy-duty and versatile storage is needed for tools, gear, sports equipment, uniforms and clothing.

SECURITY-MAX™ ALL-WELDED LOCKERS



VENTILATED MODEL

SOLID MODEL

FEATURES:

BODY CONSTRUCTION: All-welded construction, 16 gauge heavy-duty body and 18 gauge back, Sides formed to be integral with front vertical frame and are reinforced using two front-to-back channel stiffeners welded to the underside.

BODY STYLES: One tier, one wide. Available in solid or ventilated versions

HANDLE: Cremone 3-point high-security turn handle latching with heavy-duty 3/8" lock rods which engage the top and bottom locker frames while the cam engages the frame at the door jamb near the handle

DOOR: 14 gauge door with a full height welded in door stiffener

HINGES: Continuous piano type

SHELVES: Upper welded hat shelf. Additional shelves can be ordered and are adjustable on 3" centers. coat rod: 3/8" diameter rod is welded to underside of upper shelf

HOOKS: Two single back hooks

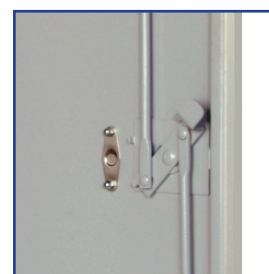

3 POINT HIGH SECURITY TURN HANDLE LATCHING

Width	Depth	Opening Height	Unit Height	Tier	Grouping	Included Shelves	Fully-Assembled Cat No.	Color Selection
VENTILATED MODELS								
18	22	72	72	1	1-wide	1	HTA822AS1	PL
24	22	72	72	1	1-wide	1	HTA422AS1	PL
SOLID MODELS								
18	22	72	72	1	1-wide	1	HTC822AS1	PL
24	22	72	72	1	1-wide	1	HTC422AS1	PL
ADDITIONAL SHELVES								
18	22						HTAS1822	PL
24	22						HTAS2422	PL



711 LIGHT GRAY (PL)

ELEGANT DESIGN FOR REFINED SPACES



BLACK TIE LOCKERS

- 16-Ga. Continuous Hinges
- Powder-Coated Finish
- Black Body And Frame

All the features of Hallowell Premium wardrobe and box lockers with the added benefit of a stylish black body and frame and the choice of black, red or light gray doors.



**SINGLE TIER,
1 WIDE
1 OPENING**



**TWO TIER,
3 WIDE
6 OPENINGS**



**THREE TIER,
1 WIDE
3 OPENINGS**



**SIX TIER,
3 WIDE
18 OPENINGS**

UPGRADED Antimicrobial Recessed Handle Finger Lift Cover

All gravity lift-type latching lockers that include recessed handles include our Antimicrobial Recessed Handle Finger Lift Cover for protection against the growth of molds and bacteria

FEATURES:

BODY CONSTRUCTION: Knock-down, 24 gauge

DOOR: Wardrobe doors are 16 gauge, box doors are 18 gauge. Louvered for ventilation

HINGES: Continuous piano type

HANDLE: Stainless steel recessed handle with multi-point gravity lift-type latching for wardrobe doors. Box doors have friction catch finger pull handle.

HOOKS: Single and double tier models include two single prong hooks. Triple tier includes one double prong hook. No hooks at six tier.

COAT RODS: One at vertical wardrobe section.

SHELVES: Single tier model includes a hat shelf.

		Overall Dimensions (in.)			Door Color	UNASSEMBLED Item No.	ASSEMBLED Item No.
W	H	D					
SINGLE-TIER WARDROBE							
1 wide	1 opening	12	72	18	Black	U1282-1ME	U1282-1A-ME
3 wide	3 openings	36	72	18	Black	U3282-1ME	U3282-1A-ME
1 wide	1 opening	12	72	18	Light Gray	U1282-1MP	U1282-1A-MP
3 wide	3 openings	36	72	18	Light Gray	U3282-1MP	U3282-1A-MP
1 wide	1 opening	12	72	18	Red	U1282-1MR	U1282-1A-MR
3 wide	3 openings	36	72	18	Red	U3282-1MR	U3282-1A-MR
DOUBLE-TIER WARDROBE							
1 wide	2 openings	12	72	18	Black	U1282-2ME	U1282-2AME
3 wide	6 openings	36	72	18	Black	U3282-2ME	U3282-2AME
1 wide	2 openings	12	72	18	Light Gray	U1282-2MP	U1282-2AMP
3 wide	6 openings	36	72	18	Light Gray	U3282-2MP	U3282-2AMP
1 wide	2 openings	12	72	18	Red	U1282-2MR	U1282-2AMR
3 wide	6 openings	36	72	18	Red	U3282-2MR	U3282-2AMP
TRIPLE-TIER WARDROBE							
1 wide	3 openings	12	72	18	Black	U1282-3ME	U1282-3AME
3 wide	9 openings	36	72	18	Black	U3282-3ME	U3282-3AME
1 wide	2 openings	12	72	18	Light Gray	U1282-3MP	U1282-3AMP
3 wide	9 openings	36	72	18	Light Gray	U3282-3MP	U3282-3AMP
1 wide	3 openings	12	72	18	Red	U1282-3MR	U1282-3AMR
3 wide	9 openings	36	72	18	Red	U3282-3MR	U3282-3AMR
SIX-TIER BOX							
1 wide	6 openings	12	72	18	Black	U1282-6ME	U1282-6AME
3 wide	18 openings	36	72	18	Black	U3282-6ME	U3282-6AME
1 wide	6 openings	12	72	18	Light Gray	U1282-6MP	U1282-6AMP
3 wide	18 openings	36	72	18	Light Gray	U3282-6MP	U3282-6AMP
1 wide	6 openings	12	72	18	Red	U1282-6MR	U1282-6AMR
3 wide	18 openings	36	72	18	Red	U3282-6MR	U3282-6AMR



BODY / FRAME COLOR	DOOR COLOR CHOICES
708 BLACK (ME)	708 BLACK (ME)
	711 LIGHT GRAY (PL)
	721 RELAY RED (RR)

BLACK TIE LOCKERS



Tried and tested by students in thousands of middle and high schools nationwide, these all-welded athletic lockers are ideal for use in institutional, industrial, fitness, manufacturing and distribution sectors.

FEATURES:

BODY CONSTRUCTION: All-welded construction, 16 gauge body, 18 gauge back. Sides are diamond perforated

DOOR: 14 gauge, diamond perforated for ventilation

HINGES: Continuous piano type

HANDLE: Stainless steel recessed handle with multi-point gravity lift-type latching for wardrobe doors. Box doors have friction catch finger pull handle.

HOOKS: Single and double tier models include two single prong hooks . Triple tier includes one double prong hook. No hooks at six tier.

SHELVES: Single tier model includes a hat shelf.



UPGRADED Antimicrobial Recessed Handle Finger Lift Cover

All gravity lift-type latching lockers that include recessed handles include our Antimicrobial Recessed Handle Finger Lift Cover for protection against the growth of molds and bacteria



Single Tier,
1 wide
1 opening

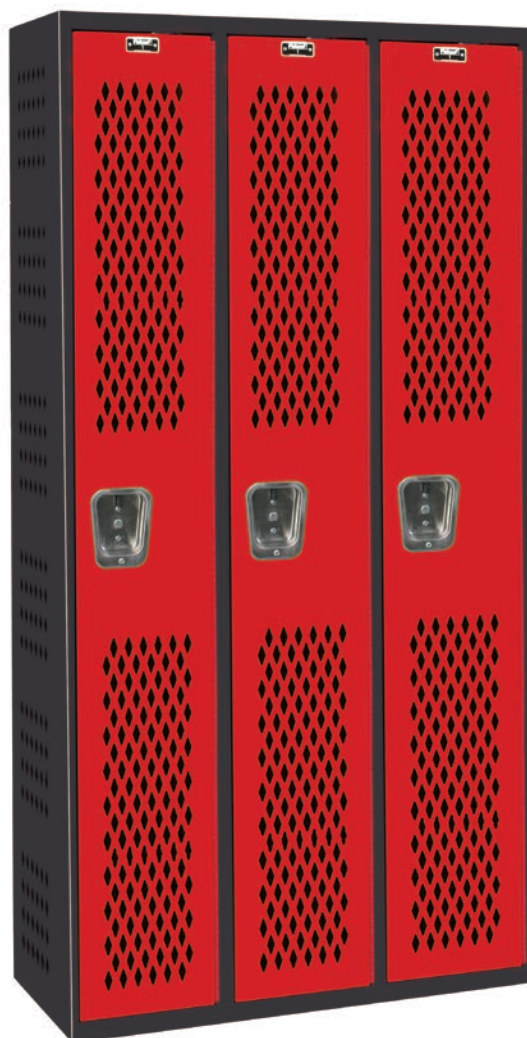

Single Tier,
3 wide
3 opening

ELEGANT FOR THE CLUB
DURABLE FOR THE GYM



Hallowell
Hallowell-List.com



**TWO TIER,
1 WIDE
2 OPENING**

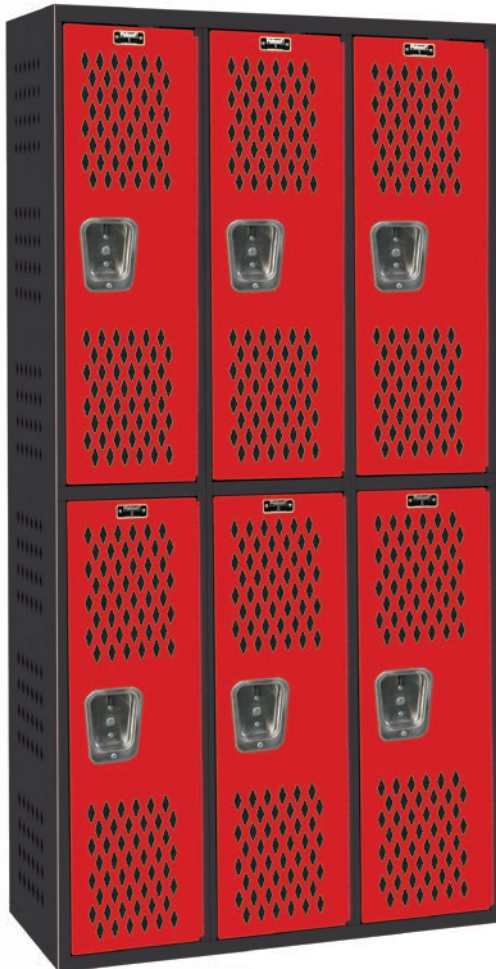

**TWO TIER,
3 WIDE
6 OPENING**

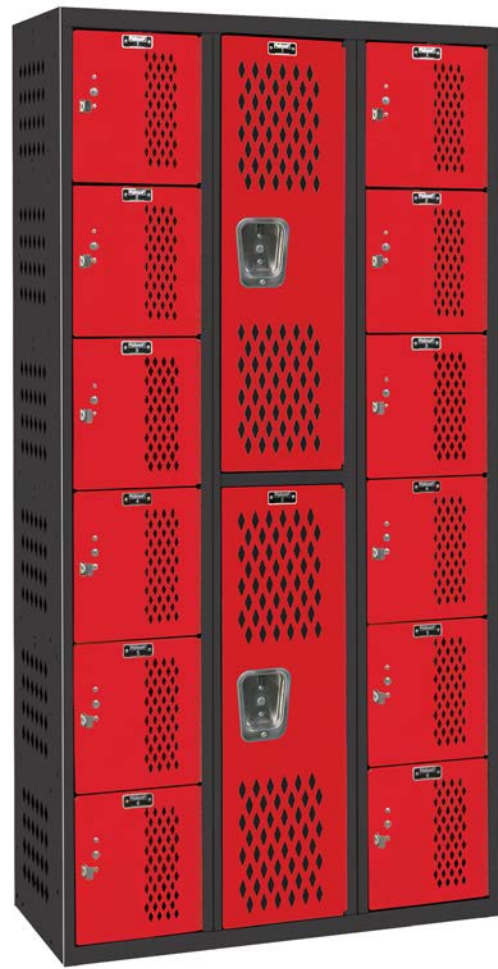

**TWO TIER, SIX TIER COMBO
3 WIDE
14 OPENING**

PE & GYM STOCK LOCKERS

		Overall Dimensions (in.)			Item No.
		W	H	D	
SINGLE-TIER WARDROBE					
1 wide	1 opening	12	72	18	AWA282-1MR
3 wide	3 openings	36	72	18	AWA282-111MR
DOUBLE-TIER WARDROBE					
1 wide	2 openings	12	72	18	AWA282-2MR
3 wide	6 openings	36	72	18	AWA282-222MR
COMBO UNIT					
3 wide	14 openings	36	72	18	AWA282-626MR



708
BLACK BODY
(ME)

721
RELAY RED DOOR
(RR)

5 DAY SHIPPING ON ALL IN-STOCK PRODUCTS

24/7 PARCEL LOCKER

Easily Manage Tenant Package Delivery

**HALLOWELL® 24/7 PARCEL LOCKER LETS
YOU RECEIVE AND PICK UP ANYTIME.**

CONCIERGE...

1. Receives package for tenant
2. Places package in locker
3. Locks door using 4-digit PIN
4. Texts or emails Locker Number and PIN to Tenant

TENANT, AT HIS/HER CONVENIENCE...

1. Enters PIN into lock of appropriate locker
2. Removes package
3. Closes door of now empty locker, PIN is erased
4. Locker is ready for the next package

FEATURES:

BODY CONSTRUCTION: All-welded construction, 16 gauge body, 18 gauge back.

DOOR: 14 gauge solid door with electronic lock

HINGES: Continuous piano type

SHIPS FULLY-ASSEMBLED



HEPL842-99
18-DOOR PARCEL LOCKER
36" x 24" x 72" Unit
(18) 18" x 8" Doors



HEPL842-77
14-DOOR PARCEL LOCKER
36" x 24" x 72" Unit
(12) 18" x 8" Doors
(2) 18" x 24" Doors



The locker features the NEW Hallowell DIGITECH™ H1 digital lock, a slimline ultra modern look and simple to operate.

LOCKER FEATURES

- All-Welded Unibody Construction
- 14 Gauge solid steel doors with 16 Gauge piano hinge
- 16 Gauge solid steel body & 18 Gauge steel backs
- DigiTech H1 electronic locks
- Ships fully-assembled



NEW DIGITECH H1 ELECTRONIC LOCKS

SECURITY CODE LOCK FEATURES

- 8-digit master and sub-master codes for two levels of management security.



CR123 LITHIUM BATTERY (INCLUDED)

- Provides over 10,000 normal uses.
- LED's Flash to indicate low battery level



- Secure pop-out turn handle (flush when locked)

MASTER KEY

- Locker can be opened with master key if batteries are exhausted.

PERMANENT MODE TOO

- User enters a pre-programmed 4-digit code to unlock and use locker repeatedly.



PARCEL LOCKERS



HEPL842-55
10-DOOR PARCEL LOCKER
36" x 24" x 72" Unit
(6) 18" x 8" Doors
(4) 18" x 24" Doors



HEPL842-33
6-DOOR PARCEL LOCKER
36" x 24" x 72" Unit
(6) 18" x 24" Doors



HEPL842-22
4-DOOR PARCEL LOCKER
36" x 24" x 72" Unit
(4) 18" x 36" Doors



HEPL842-11
2-DOOR PARCEL LOCKER
36" x 24" x 72" Unit
(2) 18" x 72" Doors

Width	Depth	Height	Doors	Openings sizes	Assembled Cat No.	Color
PARCEL LOCKERS						
36	24	72	18	(18) 18" x 8"	HEPL842-99	PL
36	24	72	14	(12) 18" x 8" & (2) 18" x 24"	HEPL842-77	PL
36	24	72	10	(6) 18" x 8" & (4) 18" x 24"	HEPL842-55	PL
36	24	72	6	(6) 18" x 24"	HEPL842-33	PL
36	24	72	4	(4) 18" x 36"	HEPL842-22	PL
36	24	72	2	(2) 18" x 72"	HEPL842-11	PL



711 LIGHT GRAY (PL)



Hallowell® Bulk Storage Lockers are the ideal solution for condos and any facility that requires additional secure storage capability.

Hallowell® Bulk Storage Lockers are the most economical way to provide safe and secure storage in virtually any facility. Cost effectiveness and ease of installation make Bulk Storage Lockers the perfect choice when additional storage is needed. Choose from in-stock or custom sizes to fit your needs.

The use of Hallowell® Bulk Storage Lockers creates an esthetically appealing installation that when properly promoted can be a tremendous asset to the building and of great value to the users.

- SINGLE & DOUBLE TIER MODELS
- ECONOMICAL
- SECURE
- DURABLE
- FAST & EASY INSTALLATION
- LOW LIFE-CYCLE COST
- ATTRACTIVE
- USER FRIENDLY

RIGIDITY • STRENGTH • SAFETY • SECURITY



Bulk Storage Lockers feature **SafeMesh84™**, the industry's strongest and safest expanded metal.

- ✓ 84% MORE STEEL THAN 3/4" MESH
- ✓ 84% MORE STEEL = MORE RIGID UNIT
- ✓ 1/2" MESH KEEPS FINGERS OUT
- ✓ REDUCES RISK OF LOSS, THEFT AND CONTENT DAMAGE



WE USE

1/2" MESH 16 GAUGE
FLATTENED EXPANDED METAL



THEY USE

3/4" MESH 16 GAUGE
FLATTENED EXPANDED METAL

Shown with optional expanded metal top

13" transom

Heavy-duty 2-knuckle lift off hinge

Welded door brace for added rigidity

Welded padlock hasp and ergonomic welded-on door pull

1/2" 16 gauge flattened expanded metal doors and sides

Heavy-gauge vertical frame channels and

Horizontal frame angles

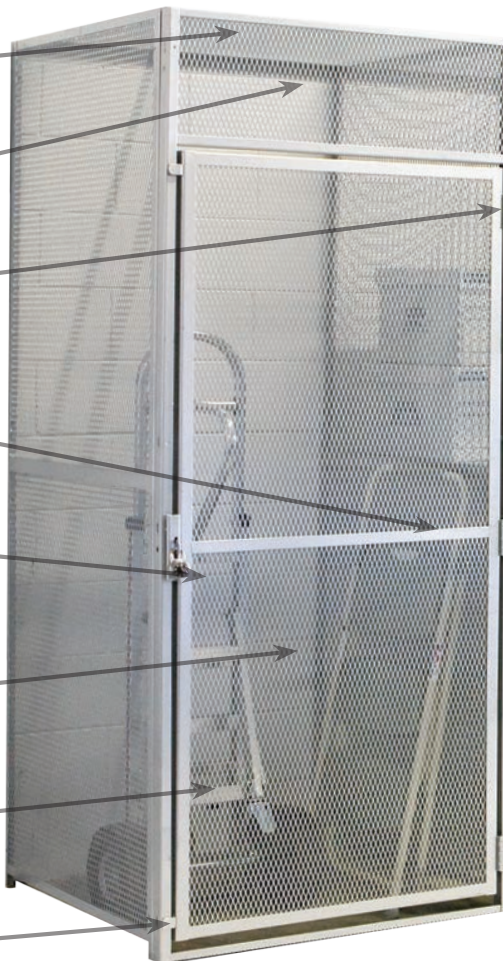

SINGLE TIER STARTER UNIT



Padlock hasp & Ergonomic one piece door pull is welded to the door frame.



Heavy-Duty 2-knuckle lift off hinges and door stops are welded to the frame for extra strength and security for a more finished and attractive appearance.



Optional 16 gauge 1/2" expanded metal top makes for security & rigidity for a higher level of protection from theft



NEW STOCK COLOR

725 DARK GRAY (HG)

Easy Custom Installations

Hallowell® Bulk Storage Lockers' unique construction provides for a simple, easy way of handling interference from overhead pipes and/or ducts.

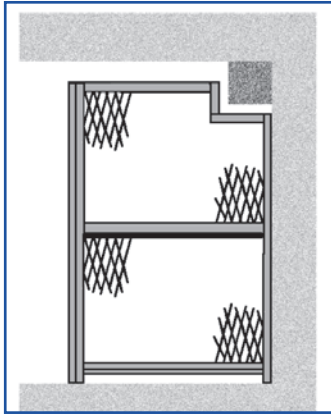

SHOWING CUT OUT (WITH REPAIR ANGLES) TO ALLOW FOR INTERFERING DUCT.

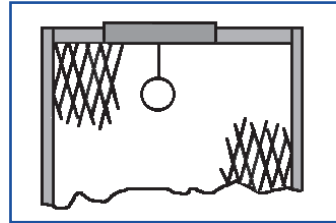

VIEW OF PIPE THROUGH TRANSOM (OR DIVIDER) WITH REPAIR ANGLE.

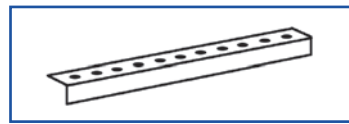

REPAIR ANGLES

Repair Angle 16 gauge 36" long repair angle is pre-punched on 2" centers to "heal" cuts in dividers or transom. Two bolts and clips are included with each angle.

RED denotes stock sizes. Custom sizes are also available.

Tops are recommended for situations where the ceiling height is 8'-6" or more when using standard 7'-6" high component modules.

Shelves are used as dividers between top and bottom openings of double tier lockers. May also be used in single tier lockers for additional floor space and may be shorter than depth of locker to provide space for long items.

Backs are required for back-to-back installations or where a single row is set away from a wall.

Bottoms are recommended for use on all single or double tier lockers if dampness prevails.

UNITS AVAILABLE RIGHT-HAND OR LEFT-HAND HINGED

- **SINGLE TIER:**
 - OVERALL HEIGHT 90"
 - OPENING HEIGHT: 75-1/2"
- **DOUBLE TIER:**
 - OVERALL HEIGHT 90"
 - UPPER OPENING HEIGHT: 31-1/2"
 - LOWER OPENING HEIGHT: 42"

Note: In the interest of safety, all lockers must be securely anchored to the floor and/or wall.

STORAGE LOCKER STOCK SIZES

Standard Sizes available in single & double tier configuration.	
Width	3'-0", 4'-0"
Depths	3'-0", 4'-0", 5'-0"
Height	7'-6"

W	D	H	STARTER UNITS		ADDER UNITS	
			Part No. Right Hinged)	Part No. (Left Hinged)	Part No. Right Hinged)	Part No. (Left Hinged)
SINGLE TIER						
36	36	90	BSL363690-R-1S-HG	BSL363690-L-1S-HG	BSL363690-R-1A-HG	BSL363690-L-1A-HG
36	48	90	BSL364890-R-1S-HG	BSL364890-L-1S-HG	BSL364890-R-1A-HG	BSL364890-L-1A-HG
36	60	90	BSL366090-R-1S-HG	BSL366090-L-1S-HG	BSL366090-R-1A-HG	BSL366090-L-1A-HG
48	36	90	BSL483690-R-1S-HG	BSL483690-L-1S-HG	BSL483690-R-1A-HG	BSL483690-L-1A-HG
48	48	90	BSL484890-R-1S-HG	BSL484890-L-1S-HG	BSL484890-R-1A-HG	BSL484890-L-1A-HG
48	60	90	BSL486090-R-1S-HG	BSL486090-L-1S-HG	BSL486090-R-1A-HG	BSL486090-L-1A-HG
DOUBLE TIER						
36	36	45	BSL363690-R-2S-HG	BSL363690-L-2S-HG	BSL363690-R-2A-HG	BSL363690-L-2A-HG
36	48	45	BSL364890-R-2S-HG	BSL364890-L-2S-HG	BSL364890-R-2A-HG	BSL364890-L-2A-HG
36	60	45	BSL366090-R-2S-HG	BSL366090-L-2S-HG	BSL366090-R-2A-HG	BSL366090-L-2A-HG
48	36	45	BSL483690-R-2S-HG	BSL483690-L-2S-HG	BSL483690-R-2A-HG	BSL483690-L-2A-HG
48	48	45	BSL484890-R-2S-HG	BSL484890-L-2S-HG	BSL484890-R-2A-HG	BSL484890-L-2A-HG
48	60	45	BSL486090-R-2S-HG	BSL486090-L-2S-HG	BSL486090-R-2A-HG	BSL486090-L-2A-HG

ACCESSORIES FOR BULK STORAGE LOCKERS			
W	D	H	Part No.
TOP PANELS			
36	36		4803636HG
36	48		4803648HG
36	60		4803660HG
48	36		4804836HG
48	48		4804848HG
48	60		4804860HG
FRONT EXTENSION PANELS			
6		90	4600690HG
12		90	4601290HG
18		90	4601890HG
24		90	4602490HG
BACK PANELS			
36		90	4703690HG
48		90	4704890HG
REPAIR ANGLES			
36			20100HG



RECRUITER™
WOOD SPORT LOCKERS

Reinforce your commitment to your players!

Equip them with the industry's finest all-wood sport lockers. Recruiter™ custom wood sport lockers are made to order, and offer a variety of different options allowing you to tailor your locker room to your team's specific requirements.

Optional Features



Optional LED Lighting under locker top and/or under shelf



Optional USB & 110 power outlet inside upper security box



Optional dual fan ventilation system for forced air ventilation of foot locker



CUSTOM WOOD SPORT LOCKERS



BASKETBALL



FOOTBALL



HOCKEY

We can design to meet your exact requirements.

In addition to our standard designs and sizes, our engineers are readily available to assist you in custom designing a locker to meet your specific needs. Be it a fitness center,

team locker room, country club or resort health spa, we stand behind our product with a full one year warranty that covers defects in materials and workmanship.

Five Side Options



Set Back Sides



Full Curve Sides



Standard Sides



Slant Sides



Half Curve Sides

CUSTOM WOOD SPORT LOCKERS

Optional Features

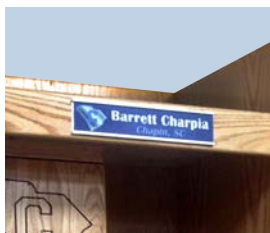

Name plate holders



Shoulder pad rack



Shoulder pad & Helmet rack



Foot locker front panel mesh insert



UV Full Color Print on security box door



Padded Seat Cushion

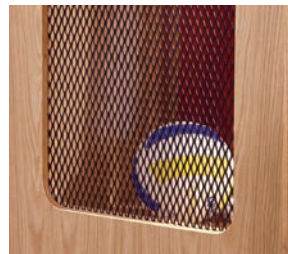

Expanded metal side inserts for additional ventilation

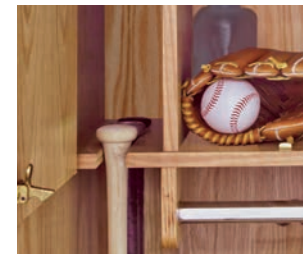

Optional Bat / Lacrosse Stick Caddy

LOCK OPTIONS: • PADLOCK • BUILT IN COMBINATION LOCK • MECHANICAL LOCK • ELECTRONIC LOCK

CUBBIE™

CHILDREN SAFE!

Hallowell Cubbie Locker line is designed to meet the needs of early childhood and elementary school classrooms. Combining our unibody all-welded locker construction and the added safety features required for this specialized market, we offer four distinct models designed to meet any child's personal storage needs. Hallowell Cubbies are backed by our written lifetime Warranty.

4 MODELS & 24 COLORS



Primary
Cubbie



Primary II
Cubbie



Primary Jr.
Cubbie



Backpack
Cubbie



HEMMED AND BEADED EDGES
ELIMINATE SHARP EDGES

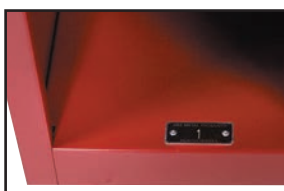

NUMBER PLATE IN BOTTOM OF CUBBIE
SO CHILDREN CAN EASILY IDENTIFY
THEIR CUBBIE SPACE.

**ALL EDGES ARE
ROUNDED OR
HEMMED FOR
SMOOTH TOUCH**



MODEL SIZES	WIDTH	DEPTH	HEIGHT
PRIMARY CUBBIE	12", 15"	12", 16"	48"
PRIMARY II CUBBIE	12", 15"	12", 16"	48"
PRIMARY JR. CUBBIE	12", 15"	12", 16"	24"
BACKPACK CUBBIE	15", 18"	12", 16"	48"

FEATURES

BODY CONSTRUCTION: Unibody all-welded 16 gauge steel construction, backs are 18 gauge, bottom is galvaneal sheet steel for maximum corrosion resistance, hemmed and beaded edges are safe to the touch

BODY STYLES: Open design, 4 body styles

SHELVES: 16 gauge welded to body for added rigidity with a beaded leading edge for added safety

NOTES: Easily secures to wall and floor for added safety, Low installation costs, reduced installation time, low maintenance, low life-cycle cost, lifetime warranty, insect and termite proof. All welded cubbies will ship in multiple column units up to 60" wide to meet individual job site conditions.





OpenGear™

THE PERFECT GEAR LOCKER

These lockers feature our unique Unibody Design which provides unsurpassed strength and durability.

HSL-00 Open Front Gear Lockers

Our complete line-up of open-front gear lockers are specifically engineered for High School, Collegiate and Professional team organizations who demand high performance equipment storage solutions.

The all-welded Open Front Gear lockers are designed to accommodate a wide variety of equipment and apparel while allowing maximum ventilation.

The base model includes one upper hat shelf with a compliment of coat hooks. You can add a choice from three upper security compartments for personal storage: a small wallet security box, a 12" wide side hinged security box or the full width top hinged security compartment.

In the lower area, you can add a shelf/seat or opt for the foot locker/seat for a lockable equipment storage area. You can finish off your sport locker with our optional stainless steel coat rod.

Open Front Gear lockers feature our all-welded Unibody design which provides two front frame channels between sides of multiple column units and integral sides which are diamond perforated for ventilation.



BASE MODEL OFFERS UPPER HAT SHELF AND COAT HOOKS



SHOWN WITH OPTIONAL 12" WIDE SECURITY BOX, STAINLESS STEEL COAT ROD AND FOOT LOCKER/SEAT

SECURITY-PLUS™ VENTILATED FRONT PANEL

ANTIMICROBIAL PROTECTION

UPGRADED Antimicrobial Box Door Finger Pulls



All box door finger pulls are made of a super tough nylon material which includes an Antimicrobial agent offering protection against the growth of molds and bacteria.



SHOWN WITH OPTIONAL WALLET SECURITY BOX AND STAINLESS STEEL COAT ROD



SHOWN WITH OPTIONAL FULL-WIDTH SECURITY COMPARTMENT, AND STAINLESS STEEL COAT ROD, AND LOWER SEAT/SHELF. DOOR INCLUDES SECURITY-PLUS™ VENTILATION.



OPTIONAL STAINLESS STEEL COAT ROD



UNDERSIDE OF FOOT LOCKER SEAT IS REINFORCED TO SUPPORT TODAY'S ATHLETE.

LOCKER SIZES:

Widths 12", 15", 18", 24", 30", 33" and 36"
 Depths 12", 16", 18", 22"
 Column Heights 60", 72", 84"

Note: Lockers will ship in multiple column units up to 60" wide to meet individual job site conditions.

ALL-WELDED OPEN-FRONT SPORT LOCKERS

HTHV-01 Turn-handle Ventilated Lockers



3-Point projecting
turn-handle
latching

STANDARD SIZES FOR ALL-WELDED WARDROBE LOCKERS

	SINGLE TIER	DOUBLE TIER	TRIPLE TIER
Widths	9", 12", 15", 18", 24"	9", 12", 15", 18", 24"	9", 12", 15", 18", 24"
Depths	12", 16", 18", 22"	12", 16", 18", 22"	12", 16", 18", 22"
Opening Heights	48", 60", 72"	24", 30", 36"	20", 24"
Nominal Column Heights	48", 60", 72"	48", 60", 72"	60", 72"

NOTE: All welded lockers will ship in multiple column units up to 60" wide to meet individual job site conditions

FEATURES:

BODY CONSTRUCTION: Unibody all-welded construction, 16 gauge 1-1/2" high continuous bottom with reinforcing channels welded to the underside at each side panel providing a rigid unit base, 16 gauge continuous top, 16 gauge diamond perforated sides are integral with front vertical frame, 18 gauge solid back

DOORS: 14 gauge diamond perforated doors are standard. Plain, Secure-Air-Flow, and louvered door styles are available

HANDLE: 3-point turn-handle latching

DOOR STRIKE: Continuous vertical door strike at both hinge and latch side

LATCHING: 3-point turn-handle latching engaging at frame top, bottom and center side of door, 3/8" diameter lock rods are the heaviest in the industry, 3/16" turn-handle welded to 11 gauge cam, 11 gauge lock plate keeper is welded to center side of frame

HINGES: 16 gauge continuous piano hinge

SHELVES: 16 gauge hat shelf for single tier openings 60" and 72" high, 16 gauge intermediate shelves

HOOKS: 2-single hooks and 1-double hook is standard. 1-double hook only for triple tier and 1-double and 1-single hook for 9" wide openings 30" and higher

WARRANTY: Lifetime

SIZES: See All Welded Chart for standard wardrobe lockers

HGLV-02 Gravity Latch Ventilated Lockers



UPGRADED Antimicrobial Recessed Handle Finger Lift Cover

All gravity lift-type latching lockers that include recessed handles include our Antimicrobial Recessed Handle Finger Lift Cover for protection against the growth of molds and bacteria

FEATURES:

BODY CONSTRUCTION: Unibody all-welded construction, 16 gauge 1-1/2" high continuous bottom with reinforcing channels welded to the underside at each side panel providing a rigid unit base, 16 gauge continuous top, 16 gauge diamond perforated sides are integral with front vertical frame, 18 gauge solid back

DOORS: 14 gauge diamond perforated doors are standard. Plain, Secure-Air-Flow, Safety-View and louvered door styles are available

HANDLE: Deep-drawn seamless stainless steel recessed handle

DOOR STRIKE: Continuous vertical door strike at both hinge and latch side

LATCHING: 12 gauge latch hooks MIG welded to frame, gravity lift-type multi-point spring loaded latching:

- 3-point latching for openings 48" high and higher
- 2-point latching for openings 20" high thru 36" high

HINGES: 16 gauge continuous piano hinge

SHELVES: 16 gauge hat shelf for single tier openings 60" and 72" high, 16 gauge intermediate shelves

HOOKS: 2-single hooks and 1-double hook is standard. 1-double hook only for triple tier and 1-double and 1-single hook for 9" wide openings 30" and higher

WARRANTY: Lifetime

SEE ABOVE CHART FOR
STANDARD SIZES



HGLS-03 Gravity Latch Solid Sides



Seamless deep drawn stainless steel recessed handle with gravity lift-type latching



UPGRADED Antimicrobial Recessed Handle Finger Lift Cover

All gravity lift-type latching lockers that include recessed handles include our Antimicrobial Recessed Handle Finger Lift Cover for protection against the growth of molds and bacteria

FEATURES:

BODY CONSTRUCTION: Unibody all-welded construction, 16 gauge 1-1/2" high continuous bottom with reinforcing channels welded to the underside at each side panel providing a rigid unit base, 16 gauge continuous top, 16 gauge solid sides are integral with front vertical frame, 18 gauge solid back

DOORS: 14 gauge louvered doors are standard. Plain, Secure-Air-Flow, Safety-View and diamond perforated door styles are available

HANDLE: Deep-drawn seamless stainless steel recessed handle

DOOR STRIKE: Continuous vertical door strike at both hinge and latch side

LATCHING: 12 gauge latch hooks MIG welded to frame, gravity lift-type multi-point spring loaded latching:

- 3-point latching for openings 48" high and higher
- 2-point latching for openings 20" high thru 36" high

HINGES: 16 gauge continuous piano hinge

SHELVES: 16 gauge hat shelf for single tier openings 60" and 72" high, 16 gauge intermediate shelves

HOOKS: 2-single hooks and 1-double hook is standard. 1-double hook only for triple tier and 1-double and 1-single hook for 9" wide openings 30" and higher

WARRANTY: Lifetime

SIZES: See All Welded Chart for standard wardrobe lockers

HSPV-04 Single-Point Ventilated Lockers



Deep drawn stainless steel recessed handle with single-point latching is standard



Hallowell HSPV-04 lockers include a 3" wide 18 gauge full height door stiffener spot welded to the inner door face and MIG welded to the hinge side as well as to the top and bottom door flanges providing a rigid torque-free door. A 1-1/2" wide stiffener will be furnished for 9" wide HSPV-04 doors.

FEATURES:

BODY CONSTRUCTION: Unibody all-welded construction, 16 gauge 1-1/2" high continuous bottom with reinforcing channels welded to the underside at each side panel providing a rigid unit base, 16 gauge continuous top, 16 gauge diamond perforated sides are integral with front vertical frame, 18 gauge solid back doors: 14 gauge diamond perforated doors and full-height door stiffener are standard. Plain, Secure-Air-Flow and louvered door styles are available

HANDLE: Deep-drawn seamless stainless steel recessed handle is standard.

DOOR STRIKE: Continuous vertical door strike at both hinge and latch side

LATCHING: Single-point maintenance-free quiet latching system, 11 gauge MIG welded latch

HINGES: 16 gauge continuous piano hinge

SHELVES: 16 gauge hat shelf for single tier openings 60" and 72" high, 16 gauge intermediate shelves

HOOKS: 2-single hooks and 1-double hook is standard. 1-double hook only for triple tier and 1-double and 1-single hook for 9" wide openings 30" and higher

WARRANTY: Lifetime

SIZES: See All Welded Chart for standard wardrobe lockers

UNIBODY ALL-WELDED LOCKERS



Deep drawn stainless steel recessed handle with single-point latching

HSPS-05 Single-Point Solid Lockers

FEATURES:

BODY CONSTRUCTION: Unibody all-welded construction, 16 gauge 1-1/2" high continuous bottom with reinforcing channels welded to the underside at each side panel providing a rigid unit base, 16 gauge continuous top, 16 gauge solid sides are integral with front vertical frame, 18 gauge solid back

DOORS: 14 gauge plain doors and a full-height door stiffener are standard. Secure-Air-Flow, diamond perforated and louvered door styles are available

HANDLE: Deep-drawn seamless stainless steel recessed handle

DOOR STRIKE: Continuous vertical door strike at both hinge and latch side

LATCHING: Single-point maintenance-free quiet latching system, 11 gauge MIG welded latch

HINGES: 16 gauge continuous piano hinge

SHELVES: 16 gauge hat shelf for single tier openings 60" and 72" high, 16 gauge intermediate shelves

HOOKS: 2-single hooks and 1-double hook is standard. 1-double hook only for triple tier, 1-double and 1-single hook for 9" wide openings 30" and higher

WARRANTY: Lifetime

SIZES: See All Welded Chart for standard wardrobe lockers



Hallowell HSPS-05 lockers include a 3" wide 18 gauge full height door stiffener spot welded to the inner door face and MIG welded to the hinge side as well as to the top and bottom door flanges providing a rigid torque-free door. A 1-1/2" wide stiffener will be furnished for 9" wide HSPS-05 doors.



HBLV-06 Ventilated Box Lockers

FEATURES:

BODY CONSTRUCTION: Unibody all-welded construction, 16 gauge 1-1/2" high continuous bottom with reinforcing channels welded to the underside at each side panel providing a rigid unit base. 16 gauge continuous top, 16 gauge diamond perforated sides are integral with front vertical frame, 18 gauge solid back

DOORS: 14 gauge diamond perforated doors are standard. Louvered, Secure-Air-Flow and plain door styles are available.

HANDLE/LATCHING: Single-point thru-the-door projecting finger pull handle with padlock hasp. Optional deep-drawn seamless stainless steel recessed handle is available

HINGES: 16 gauge continuous piano hinge

SHELVES: 16 gauge hat shelf for single tier openings 60" and 72" high

SIZES: See chart below for standard box locker sizes

NOTE: 8" & 9" high box doors are top hinged with concealed 3/8" diameter continuous hinge rod

ANTIMICROBIAL PROTECTION



Single-point thru-the-door finger pull padlock hasp

Optional padlock strike plates for box doors protect finish from being marred by padlock



TIER	OPENING HEIGHT	NOMINAL COLUMN HEIGHTS
Four Tier	12", 15", 18"	48", 60", 72"
Five Tier	12", 14.4"	60", 72"
Six Tier	8", 10", 12"	48", 60", 72"
Seven Tier	(6) 10" & (1) 12"	72"
Eight Tier	8", 9"	64", 72"
Nine Tier	8"	72"

Depths for all box locker openings 12", 16", 18", 22"

4 TIER TO 9 TIER

Please note that the actual units supplied will be fabricated to meet layout and job conditions in standard width units up to 60" wide

UPGRADED Antimicrobial

Recessed Handle Finger Lift Cover & Box Door Finger Pulls

Lift covers and finger pulls are made of a super tough nylon material which includes an antimicrobial agent offering protection against the growth of molds and bacteria.



HESL-07 Equipment Storage Lockers (TA-50)

FEATURES:

BODY CONSTRUCTION: Unibody all-welded construction, 16 gauge 1-1/2" high continuous bottom with reinforcing channels welded to the underside at each side panel providing a rigid unit base, 16 gauge continuous top, 16 gauge diamond perforated sides are integral with front vertical frame, 18 gauge solid back. Optional solid sides are available

DOORS: 14 gauge diamond perforated doors with a full height door stiffener are standard. Secure-Air-Flow, diamond perforated and louvered door styles are available

HANDLE: 3-point turn-handle

DOOR STRIKE: Continuous vertical door strike at both hinge sides

LATCHING: 3/16" turn-handle welded to 11 gauge cam engaging frame at top, bottom and center side of door. 3/8" diameter lock rods

HINGES: 16 gauge continuous piano hinge

SHELVES: 16 gauge hat shelf located 12" down from top, 16 gauge lower shelf located 18" up from bottom

COAT ROD: Stainless steel full-width coat rod located under hat shelf

WARRANTY: Lifetime



3-point projecting turn-handle latching is standard.

Shown with optional Padlock Strike Plate



Shown with optional padlock strike plate

EQUIPMENT & PREMIUM LOCKERS

EQUIPMENT STORAGE LOCKER SIZES	
Widths	24", 30", 36", 48"
Depths	12", 16", 18", 22"
Heights	60", 72", 84"

Equipment Storage lockers will ship in multiple column units up to 60" wide to meet individual job site conditions.



Single Tier, 1 wide, 1 opening

Double Tier, 1 wide, 2 openings

Triple Tier, 1 wide, 3 openings

Z-Tier
A unique multi-height storage with extended hanging space on one side and built in shelf on the other, its like a two tier with the space of a single tier.



Premium KD Wardrobe Lockers

FEATURES: (DOORS 20" HIGH AND HIGHER)

BODY CONSTRUCTION: Knock down (KD) with 24 gauge solid body components

DOORS: 16 gauge louvered doors, 18 gauge for 9" wide, are standard. Plain, Secure-Air-Flow, Safety-View and diamond perforated door styles are available

FRAME: 16 gauge frame with 16 gauge horizontal cross member between doors on double and triple tier wardrobe lockers

HANDLE: Deep-drawn seamless stainless steel recessed handle door strike, continuous vertical door strike at hinge & latch side

LATCHING: 12 gauge latch hooks MIG welded to frame. Gravity lift-type multi-point spring loaded latching:

- 3-point latching for openings 48" high and higher
- 2-point latching for openings 20" high thru 36" high

HINGES: 16 gauge continuous piano hinge

HOOKS: 2-single hooks and 1-double hook is standard. 1-double hook only for triple tier and 1-double and 1-single hook for 9" wide openings 30" and higher

SHELVES: Hat shelf for single tier openings 60" and 72" high

NOTES: All production KD lockers are supplied without legs unless otherwise specified

WARRANTY: 2 years

SIZES: See Premium KD Chart for standard wardrobe lockers



UPGRADED Antimicrobial Recessed Handle Finger Lift Cover

All gravity lift-type latching lockers that include recessed handles include our Antimicrobial Recessed Handle Finger Lift Cover for protection against the growth of molds and bacteria



Latch hook is welded to frame



Premium KD Box Lockers

FEATURES: (DOORS 18" HIGH AND UNDER)

BODY CONSTRUCTION: Knock down (KD) with 24 gauge solid body components

DOORS: 18 gauge louvered doors are standard. Plain, Secure-Air-Flow, Safety-View Plus and diamond perforated door styles are available

FRAME: 16 gauge frame

HANDLE: Projecting finger pull

DOOR STRIKE: Continuous vertical door strike at both hinge and latch side

LATCHING: Single-point thru-the-door finger pull padlock hasp

HINGES: 16 gauge continuous piano hinge

NOTES: All production KD lockers are supplied without legs unless otherwise specified. Safety-View Plus polycarbonate doors are available for 12" wide x 12" high five and six tier box doors only

WARRANTY: 2 years

SIZES: See Premium KD Chart for standard Box lockers

MAX OPTION UPGRADES ALL BODY COMPONENTS TO 16 GAUGE WITH 18 GAUGE BACK

Box door single-point thru-the-door finger pull padlock hasp

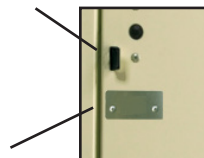

Optional padlock strike plates for box doors protect finish from being marred by padlock

ANTIMICROBIAL PROTECTION

UPGRADED Antimicrobial Box Door Finger Pulls

All box door finger pulls are made of a super tough nylon material which includes an Antimicrobial agent offering protection against the growth of molds and bacteria.



Four Tier, 1 wide, 4 openings

Five Tier, 1 wide, 5 openings

Six Tier, 1 wide, 6 openings

Premium KD Specialty Lockers



Duplex Double Tier, 2 wide, 2 openings

Two-Person Four Tier, 2 wide, 4 openings

DUPLEX

Duplex Lockers are the most economical full length lockers available. Duplex lockers provide two completely private lockers in each frame. One hat shelf and two single wall hooks are standard in each wardrobe opening. Coat rod is optional.

TWO-PERSON

Two-Person Lockers provide ample storage space for two users in a 15" wide space. Upper box doors are controlled by command latches located in the corresponding lower compartment. Two single hooks per wardrobe opening is standard. Coat rod is optional.

4-WIDE WALL MOUNT UNIT



Stainless steel recessed handle is standard for Duplex and Two-Person lockers

2 YEAR WARRANTY



SIXTEEN PERSON

lockers are the economical solution for personal security along with hanging space for full length garments. 48" wide coat rod is included

6" high legs are standard for 16-Persons lockers only

ANTIMICROBIAL PROTECTION



UPGRADED Antimicrobial Recessed Handle Finger Lift Cover & Box Door Finger Pulls

Lift covers and finger pulls are made of a super tough nylon material which includes an Antimicrobial agent offering protection against the growth of molds and bacteria.

PREMIUM KD LOCKER SIZES	WIDTH	DEPTH	OPENING HEIGHT	FRAME HEIGHT
WARDROBE				
SINGLE TIER	9" 12" 15" 18" 24"	12" 15" 18" 21" 24"	36" 48" 60" 72"	36" 48" 60" 72"
DOUBLE TIER	9" 12" 15" 18"	12" 15" 18" 21"	30" 36"	60" 72"
TRIPLE TIER	9" 12" 15" 18"	12" 15" 18" 21"	20" 24"	60" 72"
BOX				
FOUR TIER	12" 15"	12" 15" 18"	15" 18"	60" 72"
FIVE TIER	12" 15"	12" 15" 18"	15" 14.4"	60" 72"
SIX TIER	12" 15"	12" 15" 18"	12"	72"
SPECIALTY				
TWO PERSON	15" 18"	12" 15" 18"	NA	60" 72"
DUPLEX	15"	12" 15" 18"	60" 72"	60" 72"
SIXTEEN PERSON	72"	18"	12"	78" (Includes 6" legs)
FOUR WIDE WALL MOUNT	48"	18"	12"	14-3/4"

THE STANDARD FOR QUIET LOCKERS



PRODUCTION ITEMS
VISIT HALLOWELL-LIST.COM
FOR LEAD TIMES

Hallowell
Hallowell-List.com

Standard And Whisper Quiet KD Lockers

FEATURES:

BODY CONSTRUCTION: Knock down (KD) with 24 gauge solid body components

DOORS: 16 gauge plain doors (18 gauge for 9" wide), Sound deadening panel and vinyl coated latching for Whisper quiet lockers only

FRAME: 16 gauge frame with 16 gauge horizontal cross member between doors on double and triple tier wardrobe lockers

HANDLE: Deep drawn stainless steel recessed handle

DOOR STRIKE: Continuous vertical door strike at both hinge & latch side

LATCHING: 12 gauge latch hooks MIG welded to frame. Gravity lift-type multi-point spring loaded latching:

- 3-point latching for openings 48" high and higher
- 2-point latching for openings 20" high thru 36" high

HINGES: 16 gauge continuous piano hinge

HOOKS: 2-single hooks & 1-double hook is standard. 1-double hook only for triple tier & 1-double and 1-single hook for 9" wide openings 30" & higher

SHELVES: Hat shelf for single tier openings 60" and 72" high

NOTES: Production KD lockers are supplied without legs unless otherwise specified. Standard Quiet and Artisan Quiet lockers are available with plain doors only. Additional perforations/louvers in the door will increase decibel levels thus reducing the efficiency of our quiet design.

SIZES: See Premium KD Chart for standard wardrobe lockers



Silent Quiet: Double Tier, 1 wide, 2 openings
Standard Quiet: Double Tier, 1 wide, 2 openings



Sound deadening panel welded to inner door face is standard on Silent Quiet lockers only



Ventilated top and bottom door flanges



Deep drawn stainless steel recessed handle with gravity lift-type latching



12 gauge Latch hook is welded to frame

2 YEAR WARRANTY



UPGRADED Antimicrobial Recessed Handle Finger Lift Cover

All gravity lift-type latching lockers that include recessed handles include our Antimicrobial Recessed Handle Finger Lift Cover for protection against the growth of molds and bacteria

MAX OPTION UPGRADES ALL BODY COMPONENTS TO 16 GAUGE WITH 18 GAUGE BACK

STANDARD QUIET & MFQ QUIET KD LOCKERS

Maintenance-Free™ Quiet KD Lockers (MFQ)

FEATURES:

BODY CONSTRUCTION: Knock-down, 24 gauge

BODY STYLES: Single, double and triple tier

DOOR: 16 gauge, solid

HINGES: Continuous piano type

HANDLE: Deep drawn stainless steel recessed handle with single-point latching. Recessed handle protects finish from being marred by padlock.

HOOKS: One double prong ceiling hook and two single wall hooks per single and double tier opening. One double ceiling hook for triple tier.

COAT RODS: Available for single tier at a nominal cost

SHELVES: Hat shelf for single tier openings 60" and 72"

WARRANTY: 2 years

SIZES: See Premium KD Chart for standard wardrobe lockers



Single Tier, 1 wide, 1 openings
Double Tier, 1 wide, 2 openings
Triple Tier, 1 wide, 3 openings



11 gauge single-point latch



Deep drawn stainless steel recessed handle with single-point latching



MFQ lockers include a 3" wide 18 gauge full height door stiffener spot welded to the inner door face and MIG welded to the hinge side as well as to the top and bottom door flanges providing a rigid torque-free door. A 1-1/2" wide stiffener will be furnished for 9" wide MFQ doors.

MAX OPTION UPGRADES ALL BODY COMPONENTS TO 16 GAUGE WITH 18 GAUGE BACK

2 YEAR WARRANTY

PRODUCTION ORDERS CONTACT US AT 866.566.0500

Heavy-Duty Corridor KD Lockers (HDC)

Heavy-Duty Corridor lockers, commonly known as HDC lockers, are designed to include all the great features of our Standard KD wardrobe lockers with the doors upgraded to 14 gauge.

FEATURES:

BODY CONSTRUCTION: Knock down with 24 gauge solid body components

DOORS: 14 gauge louvered doors are standard. Plain, Secure-Air-Flow, Safety-View and diamond perforated door styles are available

FRAME: 16 gauge frame with 16 gauge horizontal cross member between doors on double and triple tier wardrobe lockers

HANDLE: Deep-drawn seamless stainless steel recessed handle door strike: Continuous vertical door strike at both hinge and latch side

LATCHING: 12 gauge latch hooks MIG welded to frame. Gravity lift-type multi-point spring loaded latching:

- 3-point latching for openings 48" high and higher
- 2-point latching for openings 20" high thru 36" high

HINGES: 16 gauge continuous piano hinge

HOOKS: 2-single hooks and 1-double hook is standard. 1- double hook only for triple tier and 1-double and 1- single hook for 9" wide openings 30" and higher

SHELVES: Hat shelf for single tier openings 60" and 72" high

NOTES: All production KD lockers are supplied without legs unless otherwise specified

SIZES: See Premium KD Chart for standard wardrobe lockers



Single Tier,
1 wide,
1 opening

Double Tier,
1 wide,
2 openings

Triple Tier,
1 wide,
3 openings



Deep drawn stainless steel recessed handle with gravity lift-type latching.

2 YEAR WARRANTY

MAX OPTION UPGRADES ALL BODY COMPONENTS TO 16 GAUGE WITH 18 GAUGE BACK



ANTIMICROBIAL UPGRADED Antimicrobial Recessed Handle Finger Lift Cover

All gravity lift-type latching lockers that include recessed handles include our Antimicrobial Recessed Handle Finger Lift Cover for protection against the growth of molds and bacteria

Heavy-Duty Ventilated KD Lockers (HDV)

FEATURES:

BODY CONSTRUCTION (WARDROBE & BOX LOCKERS): Knock down with 16 gauge solid top, bottom and intermediate shelves, 16 gauge diamond perforated sides, 18 gauge solid back

DOORS: 14 gauge diamond perforated doors are standard. Louvered, Security-Plus and Safety-View door styles are available

FRAME: 16 gauge frame with 16 gauge horizontal cross member between doors on double and triple tier wardrobe lockers

HINGES: 16 gauge continuous piano hinge

DOOR STRIKE: Continuous vertical door strike at both hinge and latch side

WARDROBE LOCKERS (Doors 20" and higher):

HANDLE: Deep-drawn seamless stainless steel recessed handle

LATCHING: Gravity lift-type multi-point spring loaded latching:

- 3-point latching for openings 48" high and higher,
- 2 point latching for openings 20" high thru 36" high

HOOKS: 2-single hooks and 1-double hook is standard.

- 1- double hook only for triple tier and 1-double
- 1 - single hook for 9" wide openings 30" and higher

SHELVES: 16 gauge hat for single tier openings 60" and 72" high

BOX LOCKERS (Doors 18" high and under):

HANDLE: Single-point thru-the-door finger pull padlock hasp

HOOKS: None

NOTES: All production KD lockers are supplied without legs unless otherwise specified

SIZES: See Premium KD Chart for standard wardrobe & box lockers



Double Tier,
1 wide,
2 openings

Six Tier,
1 wide,
6 openings



Deep drawn stainless steel recessed handle with gravity lift-type latching for doors 20" high and higher

2 YEAR WARRANTY



ANTIMICROBIAL UPGRADED Antimicrobial Recessed Handle Finger Lift Cover

All gravity lift-type latching lockers that include recessed handles include our Antimicrobial Recessed Handle Finger Lift Cover for protection against the growth of molds and bacteria

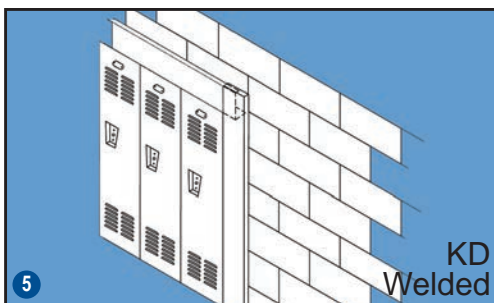
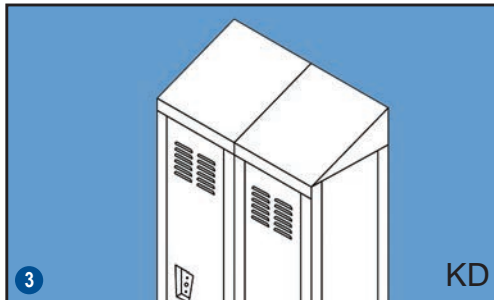
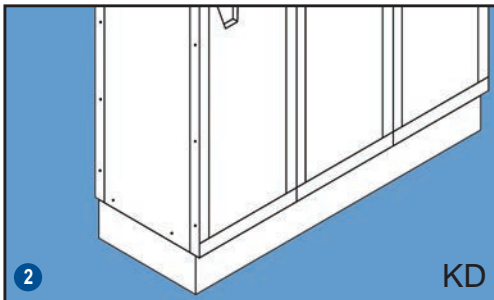
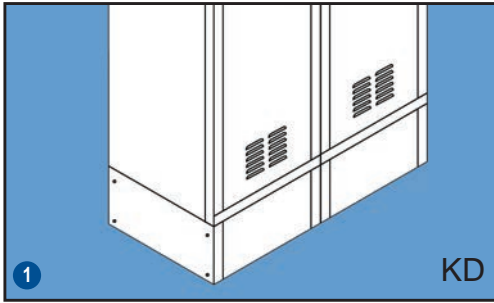

SPECIFICATIONS

- 1 **6" Closed Front Base (KD lockers only):** Shall be fabricated of 16 gauge cold rolled sheet steel flanged on all four sides for rigidity. Front bases include projecting tabs on side flanges designed to align with holes in front legs allowing front bases to be snapped into place requiring no additional fasteners. Side bases are to be included at all exposed ends and are bolted to front and rear legs. Finish to match lockers. Available Quick-Ship from stock in 5 standard colors.
- 2 **4" Continuous Z-Base (KD lockers only):** Shall be fabricated from 16 gauge cold rolled sheet steel fabricated in 72" lengths, flanged at the top to form a 1-3/8" toe space and at the bottom allowing concealed fastening to the finished floor. Continuous Front Bases include holes for use with splice plates where bases are joined end-to-end. End Bases are to be included at all exposed ends. Where additional support is desired, End Bases may be substituted for splices at Continuous Front Base joints. Finish to match lockers. Available Quick-Ship from stock in 5 standard colors.
- 3 **20 gauge Individual Slope Top (KD lockers only):** Not less than 20 gauge cold rolled sheet steel, 18 degree pitch, fabricated to be installed individually over each locker. Slope top is formed to include a full back. Individual Slope Tops are to be installed in addition to the locker flat top. End closures are to be provided at exposed ends. Finish to match lockers. Available Quick-Ship from stock in 5 standard colors.
- 4 **18 gauge Continuous Slope Top:** Not less than 18 gauge cold rolled sheet steel, 18 degree pitch, in 72" lengths. A splice cover with concealed spring clip is to be used to cover joints where Continuous Slope Tops are joined end-to-end. To be installed in addition to the locker flat top with end closures for support. Finish to match lockers. Available Quick-Ship from stock in 5 standard colors.
- 4 **16 Gauge Continuous Slope Top:** Not less than 16 gauge cold rolled sheet steel, 18 degree pitch, in 72" lengths. A splice cover with concealed spring clip is to be used to cover joints where Continuous Slope Tops are joined end-to-end. To be installed in addition to the locker flat top with end closures for support. Finish to match lockers.
- 5 **Recessed Trim:** Fabricated of 16 gauge cold rolled sheet steel. 3" wide side trim shall be notched at the top and include a retainer to allow the 3" wide top trim to fit snugly into the side trim. Recess trim is designed to be used when the lockers are installed with the locker fronts flush with the top and side walls. The top and side trim will project 3/8" beyond the side and top walls and include return bends back to the walls. Finish to match lockers. Available Quick-Ship from stock in 5 standard colors.
- 6 **Minimum Punched End Panel (KD lockers only):** Shall be from 18 gauge cold rolled steel and formed to fit tightly over the universal side panel at exposed row ends. Holes are provided at perimeter for fastening to locker. Minimum Punched End Panels are designed to cover all fasteners other than those at the perimeter of the panel. Finish to match lockers. Provide at all exposed ends. Available Quick-Ship from stock in 5 standard colors.
- 7 **Boxed End Panel:** Shall be "Boxed" type formed from 16 gauge cold rolled steel with 1" O.D. double bends on sides and a single bend at top and bottom with no exposed holes or bolts. If lockers have slope tops, end panels must be formed with slope at top to cover the ends of the slope tops. Finish to match lockers. Provide at all exposed ends.
- 8 **Fillers:** Provide where indicated, of not less than 16 gauge cold rolled sheet steel, factory fabricated to and finished to match lockers. Available Quick-Ship from stock in 5 standard colors.

Note: visit our website at www.Hallowell-List.com for complete installation details and instructions.

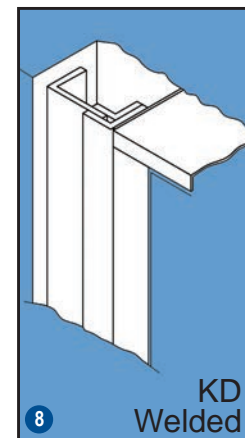
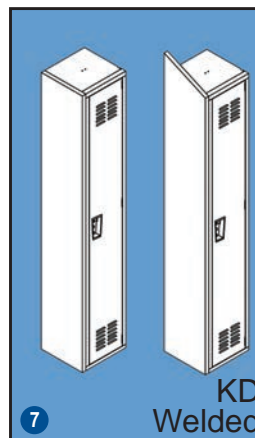
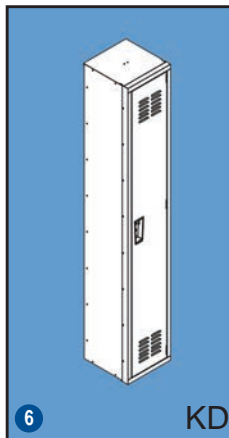

Padlocks, Built-in Locks & Specialty Locks



Master Lock Co. Built-In Combination Locks

Available in spring-bolt and dead-bolt styles, are key controlled and include multiple combination settings.



ADA Compliant
Version Available



Master Lock Co. Combination Padlocks

Available standard and master-keyed, Master Lock padlocks can be used on all locker types.



ADA Compliant
Padlocks Available



Master Lock Co. Built-In Key Locks

Available in spring-bolt and dead-bolt styles - Available in standard or master-keyed.



ADA Compliant
Version Available



Hallowell DIGITECH™ H1 Locks

Digitech™ electronic access locks can be programmed for shared or permanent use



ADA Compliant

NOTE: An ADA compliant lock must be used on any locker that is required to meet ADA guidelines.



CALL 866-566-0500 FOR
MORE INFORMATION

SAFE-O-MAT® Built-In Coin, Token & Card Locks

Available in coin return and coin collect as well as token collect and card access styles.



Hallowell DIGITECH™ GL Locks

Digitech™ GL electronic locks are compatible with all Superior® gravity lift-type latching lockers. Lock fits nicely in our recessed handle



ADA Compliant



Hallowell DIGITECH™ II RFID Locks

Digitech RFID electronic access locks can be programmed to work with most current RFID systems



ADA Compliant

NOTE: An ADA compliant lock must be used on any locker that is required to meet ADA guidelines.

Benches



WHITE NORTHERN HARD WOOD

Locker Benches are 9-1/2" wide x 1-1/4" thick, made from laminated white northern hard wood, and finished with one coat, deep-penetrating hot sealer, and two coats of heavy body, high-impact, hot, hydraulically applied lacquer. Bench tops are standard in one foot increments from 3' thru 12'. Non-standard lengths are available on special order (pedestal requirement will be for next standard size up).

SHOWN WITH 4820 PEDESTALS

BENCH TOP LENGTH	3' - 8'	9' - 12'
PEDESTALS REQUIRED	2	3

Note: Bench top lengths over 12' will be supplied in sections



PHENOLIC

Locker Benches are 9 1/2" x 3/4" Thick phenolic material in choice of 18 standard colors. Available in 1 foot increments from 3' to 12'.

SHOWN WITH 4810 PEDESTALS

BENCH TOP LENGTH	3' - 5'	6' - 8'	9' - 12'
PEDESTALS REQUIRED	2	3	4

Pedestal space not to exceed 40" O.C.



BENCHES & PEDESTALS

Pedestals



4805 Steel Pedestal
Fabricated from 10 gauge sheet steel with flanges welded to upright tube.
Color: Tan



4825 Stainless Steel Movable Pedestal
Fabricated from 16 gauge stainless steel. Includes holes for permanent anchoring to floor.
Color: Unpainted

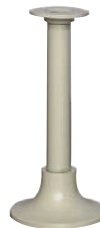

8032 Adjustable Steel Pedestal
With cast aluminum base and concealed anchoring to floor.
Color: Tan



4810 Heavy-Duty Cast Iron Pedestal With 6" diameter top and bottom. Provided with three anchoring holes at top and bottom.
Color: Tan



4820 Aluminum Movable Pedestal
Includes holes for optional permanent anchoring to floor.
Color: Tan

VERSAMAX

SOLID PHENOLIC LOCKERS

18 DESIGNER COLORS

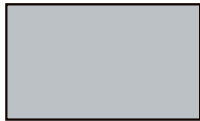

9243-58
Zen Grey



928-58
Mouse



839-58
Stop Red



7897-58
Spectrum Green



851-58
Spectrum Blue



969-58
Navy Blue



7197-58
Dover White

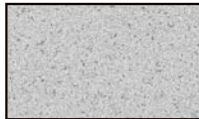

692-58
Folkstone Celesta



515-58
Graphite Graphix



7018-58
Navy Graphix

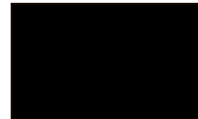

909-58
Black

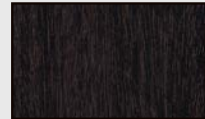

8848-58
Blackend Legno



8905-58
Waxed Maple



7012-58
Amber Maple

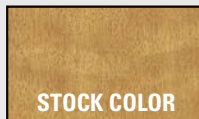

STOCK COLOR
7284-58
Figured Annigre



5487-58
Oiled Walnut

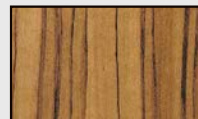

5481-58
Oiled Olivewood



5886-58
Sorrel Cherry

NOTE: All Locker body components will be made with our standard color, currently 949-58 White.

AQUAMAX

HDPE PLASTIC LOCKERS

8 COLOR CHOICES



Garnet



Slate Speckle



Sand Speckle



Slate



Taupe



Forest



Sandstone



Deep Blue

Colors shown are an approximate printed representation of the actual color and will vary depending on light source. Actual color samples are available upon request. For a more accurate color selection call or e-mail us at info@Hallowell-List.com to request actual color samples. Hallowell reserves the right to make changes to the information, illustrations, products, services, specifications, availability, plans, and terms and conditions associated with this catalog at any time, without notice, and without incurring obligations or liability of any kind.

POWDER COAT COLORS

Enhance your decor with two-tone color combinations, doors one color and frame a second color, AT NO ADDITIONAL COST.

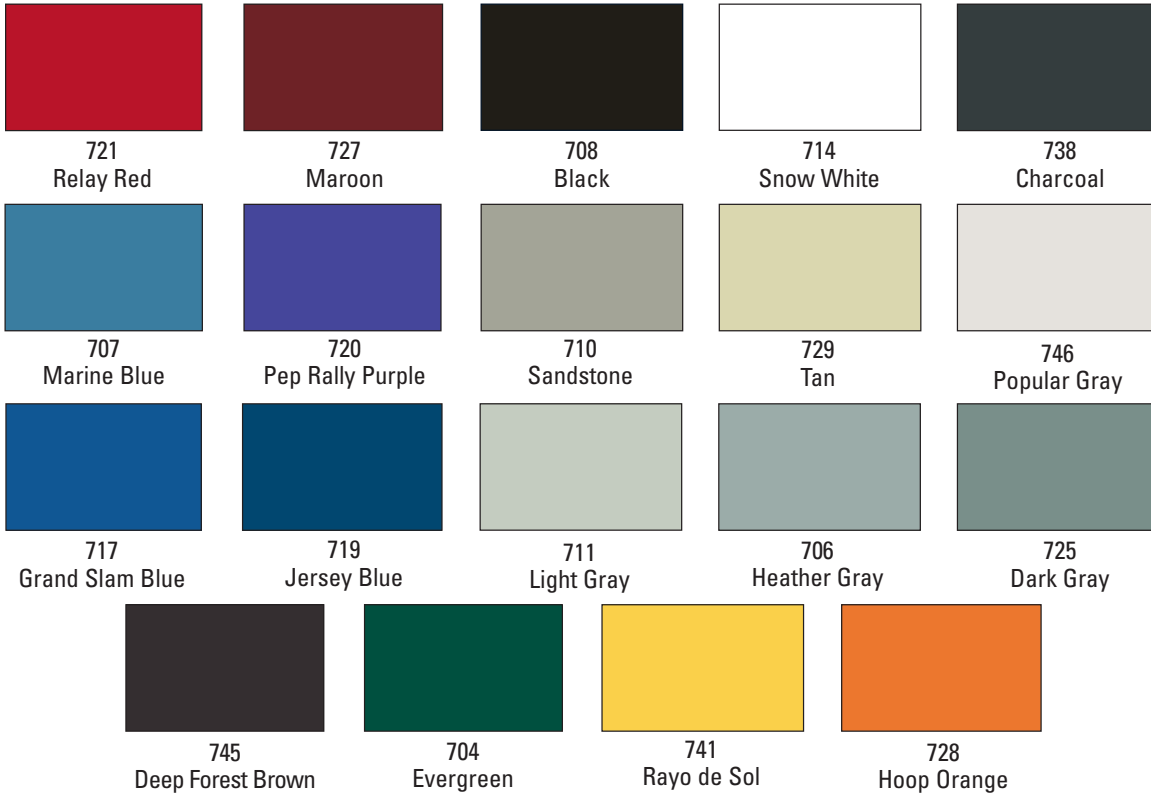

NOTE: All body components of production KD lockers will be painted our standard neutral color, currently 729 Tan (choice of 729 Tan or 725 Dark Gray for HDV body).

LOCKER PREMIUM FINISH UPGRADES ARE AVAILABLE FOR ALL 24 STANDARD COLORS
(Additional charges apply)

HAMMERTONE FINISHES

Specially formulated with a unique hammer texture that is tough, highly durable and provides long lasting protection.

Note: Patterns/colors of textures and metallics will vary due to their nature. No touch up available for hammertone finishes.

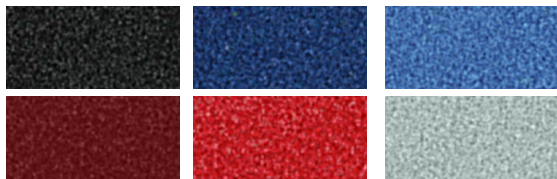

Our MedSafe™ antimicrobial finishes with Microban® are specially formulated to protect against bacteria, mold, yeast & mildew for up to 20 years! Very beneficial for educational, healthcare, food processing and other hygiene conscious environments.

Colors shown are an approximate printed representation of the actual color and will vary depending on light source. Actual color samples are available upon request. For a more accurate color selection call or e-mail us at info@Hallowell-List.com to request actual color samples. Hallowell reserves the right to make changes to the information, illustrations, products, services, specifications, availability, plans, and terms and conditions associated with this catalog at any time, without notice, and without incurring obligations or liability of any kind.

***We Stock It
You Sell It
We Ship It... Fast!
It Really Is That Easy***



2823 W. ORANGE AVE, APOPKA, FLORIDA 32703

866.566.0500

TEL: 407.464.3611 WWW.HALLOWELL-LIST.COM